

# CATALOG OF STANDARD CLAMPING TOOLS

Workpiece and tool clamping,  
indexing units







## TAILORMADE CLAMPING TECHNOLOGY

Precision made by Nann: whether high-quality standard or custom-made special clamping devices or indexing units, it is our claim to offer you optimum devices for work piece or tool clamping in most varied areas of usage at all times.

Innovative work processes, highest quality in material and machining and short delivery time – this is how you can benefit from our expertise. We deliver all standard sizes from our warehouse. Clamping devices which are not available from stock will quickly be ready for employment where you need them thanks to short production times. Our offer also includes a fast overnight service ensured by reliable logistic partners and a 24-hour regrinding service. Nann's comprehensive vertical integrati-

on makes constant high quality possible. You can rely on more than 80 years of expert craftsmanship, know-how, accuracy and state-of-the-art production facilities and benefit from the excellent price-performance ratio.

### Special clamping devices – another core area at Nann

From simple special collets to complex clamping and indexing units: development and manufacture of special clamping devices have been core competences of our company for a long time. Our portfolio comprises special collets based on standard collets, pure special collets and special collet chucks. At the beginning we focus on successful communication with our customers, in order to ensure that you will receive exactly the clamping

devices you need. Another decisive factor for you is our in-house test centre for functional tests of kinds of clamping devices.

### Dealer network

You can find comprehensive information on Nann's world-wide sales system in the menu "Contact & Representation" on our website [www.nann.de](http://www.nann.de)

### Nann – your partner for clamping technology

At Nann a skilled team with profound technical understanding awaits you. You will benefit from the close cooperation with our development and production departments.

Your request is in good hands with us.



## NANN SERVICES FOR WORKPIECE AND TOOL CLAMPING

**Nann is your competent and capable partner for services involving workpiece and tool clamping.**

**We offer a variety of different services such as internal grinding, eroding, vulcanising and coating. Our service is characterized by a high degree of flexibility and the extensive experience of our staff.**

**Our service portfolio at a glance:**

### **Internal grinding**

Within one working day we can grind used collets or collets from stock to intermediate sizes or drill out stepped holes. We can also grind used pressure sleeves or grind your used spindles for pressure sleeves with oversized dimensions.

### **Eroding**

We are in a position to erode profiles within the shortest possible times, regardless of whether they are rectangular, hexagonal or special profiles. Collets and expanding collets can also be quickly machined to match special workpiece shapes by means of erosion processes. Just ask us.

### **Vulcanising**

We seal off the slots of collets or expanding sleeves with silicon. This helps prevent the entry of dirt and machining chips. This procedure can also be done for used collets and is a service that can be carried out within 2-3 working days.







### **Coatings**

We can coat your collets and feed fingers by means of various processes. We would be glad to advise you as to which coating is suitable for your particular application. Just ask us.

#### **Plastic coating**

Plastic coatings prevent scratching of the work-piece to be clamped or scoring of the material in the case of feed fingers. A plastic coating is not of much help for relatively small drilled holes, and not possible at all for holes smaller than 5.0 mm.

#### **Hard metal coating**

A hard metal coating can be applied to collets from stock, both for round typees and profiles. The surface is made slightly rough and is very resistant to wear and abrasion, with higher friction forces. Collets or feed collets can have multiple coatings.

#### **DNC coating**

A DNC coating can be applied to collets from stock, both for round typees and profiles. The surface is made smooth and is very resistant to wear and abrasion.

#### **TIN coating**

A TIN coating can be applied to collets from stock, both for round typees and profiles. The surface is made smooth and is very resistant to wear and abrasion.

Other forms of coating are available on request.

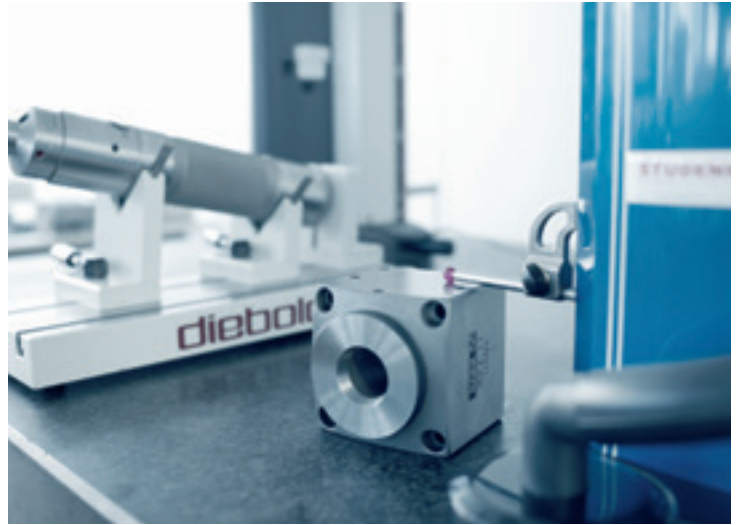

## TABLE OF CONTENTS STANDARD CLAMPING DEVICES

### Workpiece clamping

#### Collets

Deadlength collets	page	8 - 9
Multi-range collets	page	10
Feed fingers	page	11
Clamping sleeves, clamping sleeve holders for load-feeders	page	12 - 13
Pick-up collets for lathes	page	14
Guide bushes for lathes	page	15 - 17
Collets, feed fingers for multi-spindle automatic lathes	page	18 - 23
Pick-up collets for multi-spindle automatic lathes	page	24 - 25
Clamping heads	page	26 - 29
Draw-back collets	page	30 - 31
Emergency collets	page	32
Collets for rotary transfer machines – Hydromat	page	33
Draw-back collets, high precision	page	34
Chucks for draw-back collets, high precision	page	35

#### Collet chucks

Type SSF lever-operated collet chucks	page	36
Type KSFM power-operated collet chucks	page	37
Type KSKF power-operated collet chucks	page	38 - 41
Type PSF power-operated collet chucks	page	42
Type PSF-ZT power-operated collet chucks	page	43
Type HESK, HESK-R collet clamping attachments	page	44
Type HESK-RB collet clamping attachments	page	45
Type HESK-SK collet clamping attachments	page	46
Type HZ hydraulic clamping units	page	47
Type HPZ pneumatic clamping units	page	48
Type PS pneumatic clamping units	page	49
Type MSKZ manual clamping units	page	50
Type MZ manual clamping unit	page	51

#### Sleeve mandrels

Sleeve mandrels for double taper sleeves	page	52 - 53
Sleeve mandrels for type S clamping sleeves	page	54 - 55
Sleeve mandrels for type E clamping sleeves	page	56 - 57
Sleeve mandrels for type B clamping sleeves	page	58 - 59
Segmented clamping mandrels	page	60 - 61

### Tool clamping

#### Collets

DIN ISO 10897 collets for tool clamping	page	62
DIN ISO 15488 collets for tool clamping	page	63
Collets for tool clamping	page	64 - 65
Morse and ISO-taper collets for tools with cylindrical shank	page	66
Collets for multi-spindle drill heads and hand grinders	page	67

#### Collet chucks

Series J rubber collets	page	68
Type FER milling chucks for DIN ISO 15488 collets	page	69 - 72

#### Indexing units

Type NPZT pneumatic clamping units with mechanical indexing	page	73
Type VLK-8 mechanical clamping and indexing units	page	74
Type PT pneumatic clamping and indexing units	page	75
Type NT single or multi-spindle numeric indexing units	page	76
Type NTZ multi-spindle indexing units	page	77
Pneumatic/hydraulic tailstocks	page	78

**Valid from June 2017.**

**Technical modifications subject to change.**

## DEADLENGTH COLLETS

### Use:

- for workpiece clamping
- for bar or chuck work
- no axial movement while the chuck is clamping

### Bore patterns:

(G): smooth

(Q): with round grooves from 6.0 mm

(LQ): with cross grooves from 6.0 mm, serrated in the case of round bores greater than 9.0 mm; higher clamping force

### Taper angle of the clamping sleeve:

The taper of the clamping sleeve should be 15' (one-sided) flatter than the taper angles given in the tables. This frees the collets on release and provides low undersized clamping.

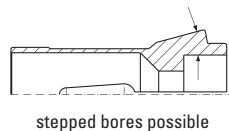
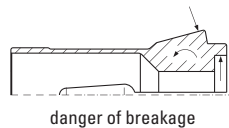

### Stepped bores:

In the case of stepped bores or when using collet stops, the clamping point should be within the taper of the collet, otherwise the collet will tend to break due to bending stresses.

### Hardness:

The collets are made from special spring steel. Where possible, by partial tempering, the hardness of the taper and clamping bore is approx. HRc 60. The shank and sprung area are hardened to spring.

### Taper grinding:

The clamping taper is lightly ground at the slot edges to ease removal of the collets from the mounting thus making possible low undersized clamping.

### Stops for collets:

Adjustable stops which are easily fitted into the rear bore of the collets. Bores are available for standard models.

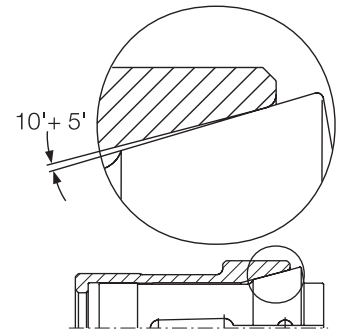
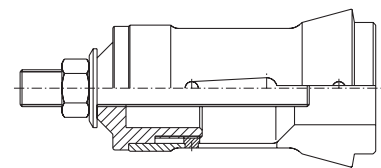

### running concentricity (truth)

clamping diameter		testing point	running concentricity	
d from	d to	L	standard	high precision
1	1,6	6	0,02	0,01
1,6	3	10	0,02	0,01
3	6	16	0,02	0,01
6	10	25	0,02	0,01
10	18	40	0,03	0,015
18	24	50	0,03	0,015
24	30	60	0,03	0,015
30	50	80	0,04	0,02
50	60	100	0,04	0,02

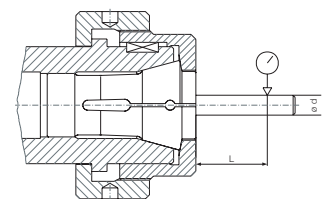

Similar to DIN 6343  
The LQ pattern may have a radial runout which is 50 % higher. The precision design attracts an additional charge.



deadlength collets

art. no.	pic.	d	D	L	K°	bore pattern			max. diameter		
						LQ	Q	G	○	⬡	□
100 E	1	6	10	30	15			*	4,5		
101 E	1	8	12	42	16			*	6		
102 E	1	8	13,7	30	21			*	5,5		
103 E	1	8	14	35	15			*	5		
109 E	1	10	15,5	47,5	20			*	7		
110 E	1	10	16	43	15			*	7		
111 E	1	10	16	46	20		*		7		
112 E	1	11	18,7	41	22			*	7,5		
113 E	2	12	15,5	30,5	10			*	10		
117 E	1	14	18	46	13			*	10		
118 E	1	14	19,5	46	15			*	10	9	7
120 E	1	15	21	64	16		*		12	9	7
1212 E	1	16	21	64	16		*		13		
125 E	1	17,5	22	51	15		*		14		
136 E	1	20	26	54	15		*		16	14	11
138 E	1	20	28	67,3	16		*		16	14	11
139 E	1	22	28	67	18		*		16	13	10
140 E	1	22	30	55	15	*	*		16	14	10
143 E	1	25	31	54	15		*		16	14	11
145 E	1	25	35	77	16		*		20	17	14
146 E	1	26	32	67	13		*		20	17	14
148 E	1	28	38	70	15	*	*		24	20	16
156 E	1	30	39,3	87	15		*		25	22	14
157 E	1	30	42	80	16		*		25	22	18
1446 E	1	30	38	65	15		*		25	22	18
161 E	1	32	45	75	15	*	*		26	22	18
1497 E	1	34	44	78	16		*		28	24	20
162 E	1	35	43	70	15		*		25	22	17
163 E	1	35	48	80	15	*	*		30	27	22
1536 E	1	37	47	92	16		*		32	27	22
164 E	1	38,08	49	108	15		*		32	27	22
171 E	1	42	55	94	15		*		37	32	26
173 E	1	48	60	94	15	*	*		42	36	28
177 E	1	58	70	94	15		*		52		
185 E	1	66	84	110	15	*	*		60	50	40
190 E	1	88	106	115	15	*			80		
193 E	1	90	107	130	15	*			80	85	70
196 E	1	112	138	120	15		*		100	85	70

Highlighted art. no. according to DIN 6343

Some collets are marked with both LQ and Q; when ordering one of them, please indicate bore patterns for pattern Q only.

Pressure sleeves and clamping fingers on request.

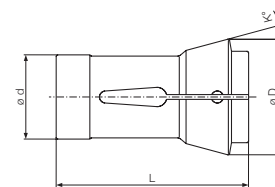

Pic. 1

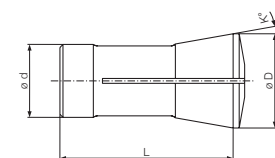

Pic. 2

## MULTI-RANGE COLLETS

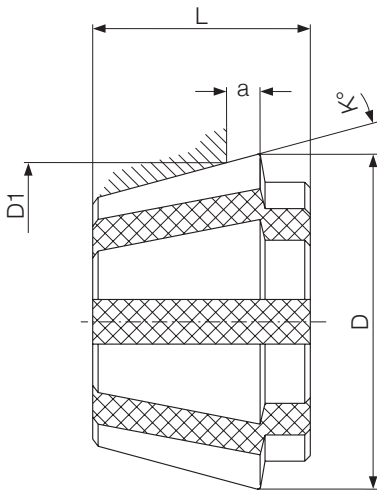

### Use:

- for workpiece clamping
- for bar or chuck work
- clamping range 2 mm
- no axial movement while chuck is clamping
- can be exchanged with DIN 6343 steel collets
- completely sealed against coolant and swarf

### Hardness:

The segments of multi-range collets are made from a special tool steel. The hardness is approx. HRc 60.

### Taper angle of the clamping sleeve:

The taper of the clamping sleeve must exactly match the taper angles of the collets given in the tables, otherwise the clamping segments will not clamp the workpiece along its entire length.

### Stops for collets:

If stops are used, the rear of the clamping segments must be supported if the clamping length is short.



### smooth bore

art. no.	exchangeable with steel coll.	rubber collets	D min	D max	a min	a max	D1	L	K°	clamping range	clamping tolerance
755 E	140 E	series 12	29,5	31,4	1	4,5	29	22	14°45'	3 - 16	+0,3 / -1,3
760 E	148 E	series 18	37,5	40,4	1	6,5	37	27	14°45'	4 - 20	+0,3 / -2,3
765 E	161 E	series 20	44,5	47,4	1	6,5	44	31	14°45'	4 - 26	+0,3 / -2,3
770 E	163 E	series 24	47,5	50,4	1	6,5	47	31	14°45'	6 - 30	+0,3 / -2,3
775 E	173 E	series 36	59,5	62,4	1	6,5	59	39	14°45'	7 - 43	+0,3 / -2,3
780 E	185 E	series 52	83,5	86,4	1	6,5	83	50	14°45'	19 - 61	+0,3 / -2,3

### serrated bore

art. no.	exchangeable with steel coll.	rubber collets	D min	D max	a min	a max	D1	L	K°	clamping range	clamping tolerance
755 E-F	173 E	series 36	59,5	62,4	1	6,5	59	39	14°45'	11 - 43	+0,3 / -2,0
780 E-F	185 E	series 52	83,5	86,4	1	6,5	83	50	14°45'	19 - 61	+0,3 / -2,0

### running concentricity

Clamping diameter		Testing point L	running concentricity	
d from	d to		standard	high precision
1	1,6	6	0,02	0,01
1,6	3	10	0,02	0,01
3	6	16	0,02	0,01
6	10	25	0,02	0,01
10	18	40	0,03	0,015
18	24	50	0,03	0,015
24	30	60	0,03	0,015
30	50	80	0,04	0,02
50	60	100	0,04	0,02

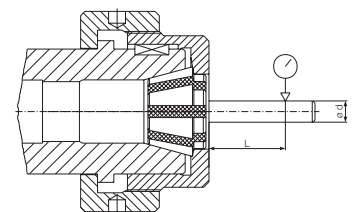

Similar to DIN 6343  
The precision design attracts an additional charge.

## FEED FINGERS

### Use:

- as feed fingers for feeding forward workpiece bars in automatic lathes
- as pick-up collets for moving up workpiece bars on NC lathes for repositioning of workpieces

### Bore patterns:

- smooth
- on request with round grooves

### Hardness:

Feed fingers are made from special spring steel. The front component with the clamping bore has a hardness of approx. HRc 60 – where this is not prevented by the partial tempering. The thread and spring areas are hardened to spring temper.

### Feed force:

Feed fingers are supplied sprung together so that, when the dimensions are nominal, they pretension the workpiece rods or workpieces.

The feed force table below gives the reference values. A hardened ground test mandrel with a tolerance of h7 must be used for checking.

Feed fingers with increased feed force can be made for an extra charge.

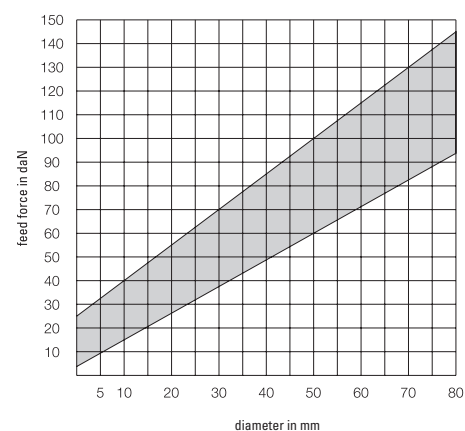

### feed fingers

art. no.	D	thread G	L	max. diameter		
				○	⬡	□
<b>207 E</b>	18	M 16 x 1 L	70	12	11	9
217 E	21	M 20 x 1 L	70	16	14	11
<b>220 E</b>	24	M 22 x 1 L	85	18	16	13
<b>236 E</b>	30	M 28 x 1 L	95	24	21	16
237 E	31	M 29 x 1 L	90	25	22	18
<b>254E</b>	42	M 40 x 1 L	116	36	31	25
<b>273 E</b>	60	M 58 x 1 L	140	52	45	36

Highlighted art. no. according to DIN 6344

### external feed fingers

art. no.	D	thread G	L	max. diameter		
				○	⬡	□
242 E	42	M 36 x 1,5	120	30	24	20
259 E	56	M 50 x 1,5	138	42	36	29
278 E	75	M 68 x 1,5	138	60	52	42

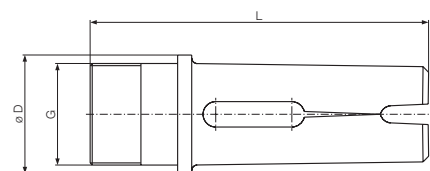
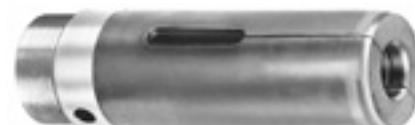
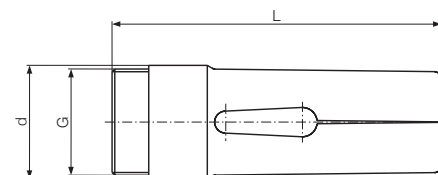

## CLAMPING SLEEVES FOR LOAD-FEEDERS

### for TRAUB and Hagenuk load-feeders

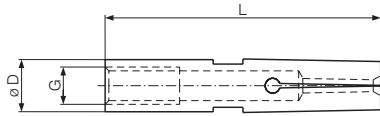

Pic. 1

art. no.	pic.	D	L	B	d / G	clamping range
200 E	1	5	37		M 4	1,5 - 4,5
208 E	1	7	37		M 5	2,0 - 5,5
210 E	2	10	40	6	7	2,5 - 8,0
212 E	2	12	40	6	8	3,0 - 10,0
203 E	2	15	40	6	11	3,0 - 13,0
203 E - 18	2	18	40	6	11	3,0 - 16,0
225 E	2	20	65	7	14	4,0 - 18,0
222 E	2	25	65	7	20	4,0 - 22,0
227 E	2	28	65	7	20	10,0 - 25,5

### for FMB-Turbo load-feeders

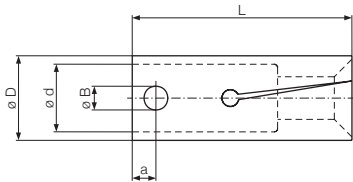

Pic. 2

art. no.	pic.	D	L	d		clamping range
2292 E	3	25	90	20		2,5 - 23
2402 E	3	30	90	20		4 - 28
2422 E	3	32	90	20		4 - 30
2490 E	3	36	90	20		5 - 33
2517 E	3	38	90	20		10 - 32
2565 E	3	40	90	20		5 - 38
2578 E	3	42	90	20		5 - 40
2610 E	3	45	90	20		6 - 42
2670 E	3	50	90	20		7 - 47
2704 E	3	54	90	20		14 - 50
2770 E	3	60	90	20		12 - 57
2780 E	3	63	90	20		14 - 60
2790 E	3	65	90	20		10 - 60
2857 E	3	73	90	20		20 - 67
2860 E	3	75	90	20		20 - 69
2912 E	3	80	90	35		50 - 72

FMB Turbo clamping sleeves are also available with annular springs from D = 42 mm

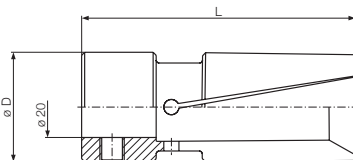

Pic. 3

### for IEMCA load-feeders

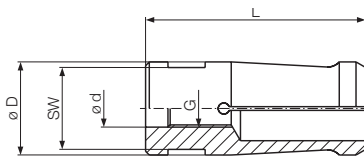

Pic. 4

art. no.	pic.	D	L	thread		clamping range
2001 E	4	7,5	40	M 5 x 0,5		3 - 6
2045 E	4	10	40	M 6 x 0,75		3 - 8
2061 E	4	12	42	M 7 x 0,75		3 - 10
2101 E	4	15	42	M 8 x 1		3 - 13
2197 E	4	20	59	M 10 x 1		10 - 18
2289 E	4	25	59	M 10 x 1		15 - 23
2316 E	4	27	59	M 10 x 1		15 - 23

## CLAMPING SLEEVE HOLDERS FOR LOAD-FEEDER

The clamping sleeve holders are used to take standard clamping sleeves in the various different load-feeders. They form the connection between the rotating clamping sleeve and the stationary feed rod.

The design of the clamping sleeve holders makes it easy to change both the clamping sleeve and the whole sleeve holder.

### for TRAUB, Hagenuk and FMB-Turbo load-feeders

art. no.	pic.	D	A	B	d	for load-feeders type
200 E-L	1	5	56,0	7	4,5	Traub, Hagenuk, FMB
208 E-L	1	7	59,0	7	6,5	Traub, Hagenuk, FMB
210 E-LH	3	10	45,5	24	8	Hagenuk, FMB
210 E-LT	2	10	45,5	24	9	Traub
212 E-LH	3	12	45,5	24	8	Hagenuk, FMB
212 E-LT	2	12	45,5	24	11	Traub
203 E-L	3	15	50,0	24	12	Traub, Hagenuk, FMB
203 E-18L	3	18	50,0	24	12	Traub, Hagenuk, FMB
225 E-L	3	20	50,0	40	17	Traub, Hagenuk, FMB
222 E-L	3	25	50,0	40	20	Traub, Hagenuk, FMB

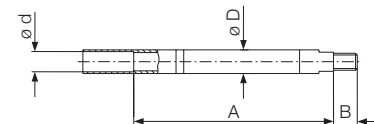

Pic. 1

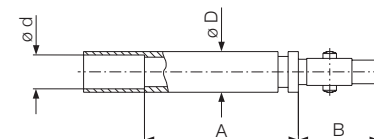

Pic. 2

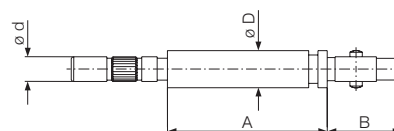

Pic. 3





## PICK-UP COLLETS

### for Index lathes

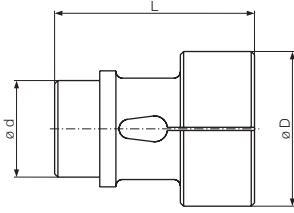

Pic. 1

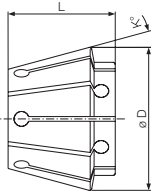

Pic. 2

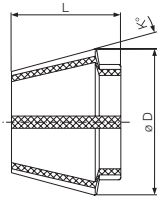

Pic. 3

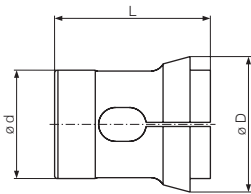

Pic. 4

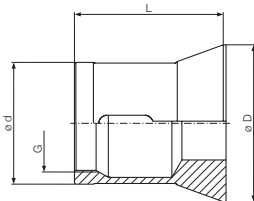

Pic. 5

art. no.	pic.	d	D	L		clamping range	for machine type
1444 E	1	30	36,0	62		3 - 30	GS 30
1462 E	1	30	48,0	62		4 - 42	GS/GB/GSC 42 - GB 65
1463 E	1	30	48,0	94		4 - 42	GE 42 - GE 65
1465 E	1	30	62,0	94		6 - 56	GS/GSC 65 - GS 100
8831 E	2		48,9	34		4 - 30	GB 30
8907 E	2		60,9	39		5 - 42	ABC 25/36/52 - GB 42/65/100 - GS 30/42 - GSC30/42
8907 E-S	3		60,9	39		5 - 42	ABC 25/36/52 - GB 42/65/100 - GS 30/42 - GSC 30/42

### for Traub lathes

art. no.	pic.	d	D	L	thread G	clamping range	for machine type
1514 E	4	35	40	46,0		1,5 - 30	TNS 30 - TNM 28
1642 E	4	46	55	65,0		2,5 - 42,5	TNS 30/42
3850 E	5	45	58	56,0	M 36 x 1	5,0 - 40,0	TNS 60/42
3880 E	5	48	60	59,5	M 40 x 1		TNS 65/42
3965 E	5	71	85	79,5	M 62 x 1	8,0 - 65,0	TNS 65

## GUIDE BUSHES FOR LATHES

### Standard guide bushes:

Drawback guide bushes are used for normal use on Swiss-type lathes. These types of guide bushes are set to the tolerance of the material to be worked using an adjustable nut. The quality of the carbide metal and the shape of the bore are chosen to achieve optimum results for most materials.

- clamping bore with carbide inserts
- very long lifetime
- high running concentricity
- standard types ex stock
- special profile bores within a few days
- grinding of bushes within one day

Special guide bushes are available for special cases where high radial forces are involved while working or when materials are difficult to machine:

- guide bushes with spiral slots
- fixed guide bushes
- broached guide bushes

Carbide guide bushes for most common Swiss-type machines available: Bechler, Citizen, Gauthier, Gildemeister, Manurhin, Petermann, Star, Strohm, Tornos, Traub etc.

### for Bechler

art. no.	d	D	L	K°	thread G	max. diameter			type
						○	⬡	□	
3077 E	1.001	9	12,5	44	M 8 x 0,75	4,5	3	2,5	A4 - A7
3078 E	265.001	9	13	52	M 9 x 0,7	4,5	3	2,5	A7
3147 E	53.001	12	15,5	50	M 10 x 0,75	7	6	4,5	A7 - A10
3149 E	261.001	12	16	52	M 12 x 1,0	7	6	4,5	A7 - A10
3383 E	120.001	20	24	55	M 20 x 1,0	13	10,5	7,5	A10
3454 E	13.001	22	29	65	M 19 x 1,0	16	11	8,0	A7 - A10
3610 E	18.001	28	38	78	M 25 x 1,0	21	17	13,0	A7 - A10
3817 E	61.001	40	48	71	M 40 x 1,0	26	23	15,0	C26
3887 E	115.001	48	56	81	M 48 x 1,25	35	30	20,0	C26 - B16 - B20

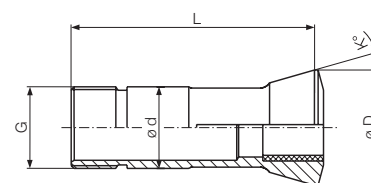

### for Citizen

art. no.	d	D	L	K°	thread G	max. diameter			type
						○	⬡	□	
3260 E	8.001	16	20,5	59	M 14 x 1	10	8,5	6,5	D10 - F10 - L10
3320 E	166.001	18	22	61	M 16 x 1	13	11	9	B12
3507 E	61.002	24	29,5	61	M 24 x 1	17	14,5	11	F16 - L16
3602 E	22.001	28	34	82	M 25 x 1	21	17	13	L20 - M20
3708 E	282.001	32	40	66	M 32 x 1	22			E20 - F20
3733 E	451.001	34	41	84,5	M 34 x 1	27	23	15	F25 - E25 - L25
3827 E	28.001	42	49	82	M 40 x 1	32	28		E32 - G32

## GUIDE BUSHES FOR LATHES

### for Gildemeister

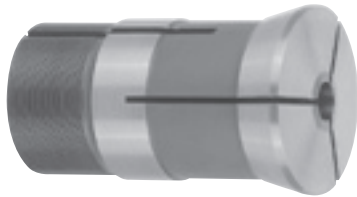
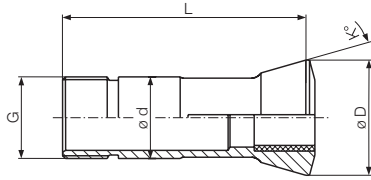

art. no.	d	D	L	K°	thread G	max. diameter			type	
						○	⬡	□		
3320 E	166.001	18	22	61	30	M 16 x 1	13	11	9	GLD12
3455 E	39.001	22	29	68	16	M 22 x 1	16,5	14	10,5	GLD16 (5-axis)
3610 E	18.001	28	38	81	30	M 25 x 1	21	17	13	GLD16 - GLD20
3733 E	451.001	34	41	87,5	10	M 34 x 1	27	23	15	GLD25 (4-axis) – GLD25 (5-axis)

### for Maier

art. no.	d	D	L	K°	thread G	max. diameter			type	
						○	⬡	□		
3602 E	22.001	28	34	82	16	M 25 x 1	21	17	13	ML18C - ML18D
3733 E	451.001	34	41	87,5	10	M 34 x 1	27	23	15	ML26C - ML26D
3827 E	28.001	42	49	82	16	M 40 x 1	32	26		ML32C - ML32D

### for Tornos

art. no.	d	D	L	K°	thread G	max. diameter			type	
						○	⬡	□		
3077 E	1.001	9	12,5	44	16	M 8 x 0,75	4,5	3	2,5	M4 - T4 - TV
3134 E	3.001	11	14,5	53	16	M 10 x 0,75	6	5	4	M7
3133 E	5.001	11	14,5	53	16	M 10 x 0,75	7	6	4,5	M7
3260 E	8.001	16	20,5	59	16	M 14 x 1,0	10	8,5	6,5	R10 - M10 - R125 - MS7
3320 E	166.001	18	21,8	60	30	M 16 x 1,0	12	11	9	R10 - M10 - R125 - MS7
3319 E	171.001	18	21,8	60	30	M 18 x 1,0	13	11	9	R10 - M10 - R125 - MS7
3454 E	13.001	22	29	65	16	M 19 x 1,0	15	11	9	M15 - R16 - RR20
3455 E	39.001	22	29	68	16	M 22 x 1,0	17	14	10	M15 - R16 - RR20
3604 E	10.001	28	33	53	20	M 28 x 1,0	20	17	13	R10 - R125
3602 E	22.001	28	34	82	16	M 25 x 1,0	20	17	13	R20
3610 E	18.001	28	38	78	60	M 25 x 1,0	21	17	13	M20 - M25/28
3765 E	32.001	38	46	57	20	M 38 x 1,25	30			M15 - R16 - RR20
3827 E	28.001	42	49	82	16	M 40 x 1,0	32	28	18	MR32
3835 E	27.001	44	53	87	20	M 40 x 1,0	32	28	18	MR32
3890 E	19.001	48	58	65	20	M 48 x 1,25	32	28	18	M20 - M25/28
3894 E	36.001	50	60	95	15	M 50 x 1,0	30			M25

## for Tornos Bechler

art. no.	d	D	L	K°	thread G	max. diameter			type	
						○	⬡	□		
3134 E	3.001	11	14,5	53,0	16	M 10 x 0,75	6	5	4	DECO 2000-7
3260 E	8.001	16	20,5	59,0	16	M 14 x 1	10	8,5	6,5	DECO 2000-10
3507 E	61.002	24	29,5	61,0	30	M 24 x 1	17	14,5	11	DECO 2000-13
3610 E	18.001	28	38,0	78,0	60	M 25 x 1	21	17	13	DECO 2000-20
3733 E	451.001	34	41,0	87,5	10	M 34 x 1	27	23	15	DECO 2000-26
3827 E	28.001	42	49,0	82,0	16	M 40 x 1	32	28	18	DECO 2000-32
3260 E	8.001	16	19,5	59,0	16	M 14 x 1	10	8,5	6,5	ENC74/75
3322 E	40.031	18	21,5	100,2	20	M 18 x 1	13	11	9	ENC74/75
3507 E	61.002	24	29,5	61,0	30	M 24 x 1	17	14,5	11	ENC162/164
3610 E	18.001	28	38,0	78,0	60	M 25 x 1	21	17	13	ENC163/167
3735 E	40.032	34	46,0	150,0	20	M 32 x 1,5	25	21	16	ENC262/264
3322 E	40.031	18	21,5	100,2	20	M 18 x 1	12,7	11	9	TOP 100
3735 E	40.032	34	46,0	150,0	20	M 32 x 1,5	25	21	16	TOP 200

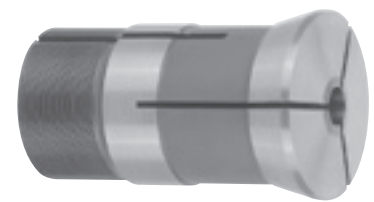
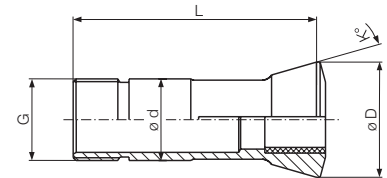

## for Traub

art. no.	d	D	L	K°	thread G	max. diameter			type	
						○	⬡	□		
3320 E	166.001	18	21,8	60,0	30	M 16 x 1	13	11	9	TNL12/7
3437 E		21	24	62,5	12	M 18 x 1	14			TNL12/7
3455 E	39.001	22	29	68,0	16	M 22 x 1	17	14	10	TNL16
3585 E	492.001	27	30	57,5	12	M 24 x 1	16	14	11	TNL12/7
3586 E	493.001	27	30	67,5	12	M 24 x 1	16	14	11	TNL12/7
3602 E	22.001	28	34	82,0	16	M 25 x 1	20	17	13	TNL16 - 20
3733 E	451.001	34	41	84,5	10	M 34 x 1	27	23	15	TNL26

## for Star

art. no.	d	D	L	K°	thread G	max. diameter			type	
						○	⬡	□		
3134 E	3.001	11	14,5	53	16	M 10 x 0,75	7	5	4	SW7 - 7
3260 E	8.001	16	20,5	59	16	M 14 x 1	10	8,5	6,5	SW7 - 10 - JNC10
3438 E	450.001	21	24	54,5	12	M 18 x 1	15	12	9	VNC12 - SNC15
3455 E	39.001	22	29	68	16	M 22 x 1	18	14	10	RNC16 - SR16 - VNC16 - SA16 - KJR16 - KNC16 - S112
3602 E	22.001	28	34	82	16	M 25 x 1	21	17	13	BR20 - KNC20 - SR20R - SV20 - VNL20 - ECAS20
3733 E	451.001	34	41	84,5	10	M 34 x 1	27	23	15	SNC25
3827 E	28.001	42	49	82	16	M 40 x 1	32	28	18	JNC25 - JNC32 - KNC32 - SR32 - VNC32

## COLLETS FOR MULTI-SPINDLE AUTOMATIC LATHES

### Use:

- for workpiece clamping
- for bar or chuck work

### Bore patterns:

- up to 6 mm: smooth bore
- from 6 mm: round grooves
- from 9 mm: serrated for round bores

### Hardness:

The collets are made from special spring steel. Where possible, by partial tempering, the hardness of the taper and clamping bore is approx. HRc 60. The shank and sprung area are hardened to spring temper.

### Taper grinding:

The clamping taper is lightly ground at the slot edges to ease removal of the collets from the mounting thus making possible low undersized clamping.

### Taper angle of the clamping sleeve:

The taper of the clamping sleeve should be 15' (one-sided) flatter than the taper angles given in the tables to ease removal of the collet from the mounting taper thus making possible low undersized clamping.

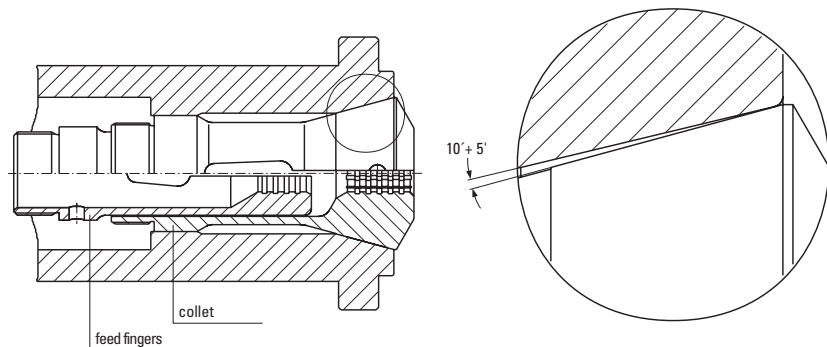



## FEED FINGERS FOR MULTI-SPINDLE AUTOMATIC LATHES

### Use:

For feeding forward workpiece bars on multi-spindle automatic lathes.

### Bore patterns:

- round grooves
- smooth bores on request

### Hardness:

Feed fingers are made from special spring steel. The front component with the clamping bore has a hardness of approx. HRc 60 – where this is not prevented by the partial tempering. The thread and spring areas are hardened to spring temper.

### Feed force:

Feed fingers are supplied sprung together so that, when the dimensions are nominal, they pre-tension the workpiece rods. The feed force table below gives the reference values.

A hardened ground test mandrel with a tolerance of h7 must be used for checking.

Feed fingers with increased feed force can be made for an extra charge.

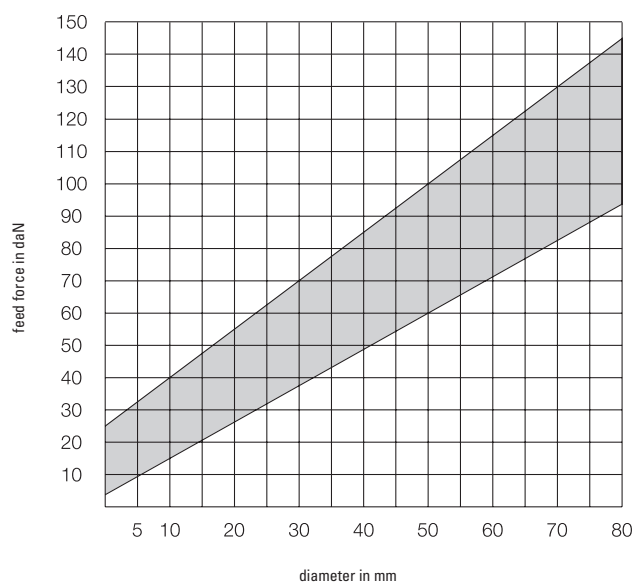

## COLLETS FOR MULTI-SPINDLE AUTOMATIC LATHES

### for Gildemeister

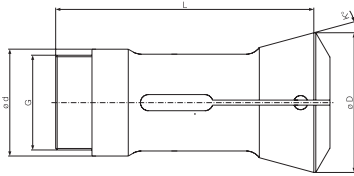

Pic. 1

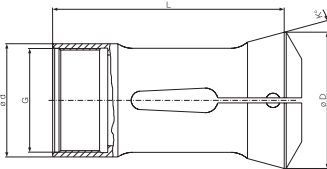

Pic. 2

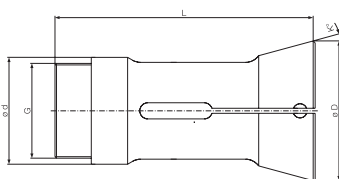

Pic. 3

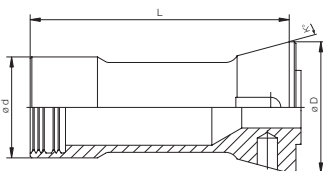

Pic. 4

art. no.	pic.	d	D	L	K°	thread G	max. diameter			type
							○	⬡	□	
9013 E	1	26,8	34,0	83,5	15	M 24 x 1,0 L	13	11	9	AS 12
9023 E	4	30	39,0	77	15	bayonet	20	17	11	GM 16 AC
9012 E	1	34	42,0	85	16	M 30 x 1,0 L	20	17	14	AS 16 - AS 20 - GM 20
9017 E	2	38	45,5	85	16	M 34,5 x 0,75 L	25	22	18	AS 20 erw. 25 - GM 20 erw.
9044 E	2	45	60,4	159	15	M 40 x 1,5 L	22	19	15	AS 22
9045 E	2	45	60,4	159	15	M 40 x 1,0 L	25	22	18	AS 25
9046 E	2	45	60,4	159	15	M 40 x 1,5 L	25	22	18	GS 25
9069 E	2	53	69,4	128	15	M 48 x 1,5 L	32	27	22	AS/AV/GM 32 - GM 35
9081 E	2	56	72,0	131	15	M 52 x 1,5 L	35	30	24	GS 35
9115 E	2	64	80,5	129	15	M 59 x 1,5 L	42	36	28	GM 42
9132 E	2	70	90,0	149	15	M 65 x 1,5 L	48	41	33	AS/AV/AA/AR 48
9151 E	2	75	97,4	165	15	M 68 x 1,5 L	50	43	35	GS 50
9151 E-1	2	75	93,4	155	15	M 68 x 1,5 L	50	43	35	GS 51
9178 E	2	90	115,0	170	15	M 85 x 1,5 L	67	58	47	AS 67
9209 E	2	109	138,0	189	15	M 102 x 1,5 L	82	70	57	AS/AV 82
9239 E	2	128	160,4	250	15	M 122 x 1,5 L	100	87	71	AS 100

### for Index

art. no.	pic.	d	D	L	K°	thread G	max. diameter			type
							○	⬡	□	
9007 E	1	32	41,5	79	15	M 28 x 1,0 L	19	16	13	MS 16
9033 E	1	40	55,2	102	15	M 35 x 1,5 Ro. L	22	19	15	KS 20 - KS 22
9039 E	3	46	60,5	112	15	M 40 x 1,5 L	25	22	18	KS/MS 25
9070 E	1	53	69,3	128	15	M 47 x 1,5 L	32	28	23	KS 32
9081 E	2	56	72,0	131	15	M 52 x 1,5 L	35	30	24	MS 35
9108 E	1	62	82,4	178	15	M 58 x 1,5 L	42	36	30	KS 42
9133 E	1	70	92,0	154,5	15,5	M 65 x 2,0 L	50	43	35	KS 50
9151 E	2	75	97,4	165	15	M 68 x 1,5 L	50	43	35	MS 50

### for Pittler

art. no.	pic.	d	D	L	K°	thread G	max. diameter			type
							○	⬡	□	
9038 E	3	44,3	56,0	136,5	15	1.9/16" x 1/18" L	25	22	18	PRC 25
9067 E	3	52,2	64,7	149	15	1.13/16" x 1/18" L	32	27	22	PRB/PRC 32
9078 E	3	57,0	69,72	149	15	2" x 1/20" L	36	31	25	PRC 36
9141 E	1	76,8	95,5	177	15	2.11/16" x 1/16" L	50	43	35	PRB/PRC 50
9206 E	1	106,0	127,7	220	15	3.13/16" x 1/18" L	72	62	51	PRC 72
9236 E	2	136,5	165,7	219	15	5.1/16" x 1/18" L	104	90	73	PRC 100

The highlighted item numbers correspond to VDI 3322.

## FEED FINGERS FOR MULTI-SPINDLE AUTOMATIC LATHES

### for Gildemeister

art. no.	pic.	d	L	thread G	max. diameter			type
					○	⬡	□	
9259 E	2	19,5	82	M 17 x 1	13	11	9	AS 12
9268 E	1	22,0	86	M 20 x 1	16	14	11	GM 16 AC
9258 E	1	25,0	90	M 24 x 1	20	17	14	AS 16 - AS/GS 20 - GM 20
9288 E	1	30,5	90	M 28,5 x 0,75	25	22	18	AS 20 erw. 25
9286 E	1	32,0	140	M 28 x 1,5 L	22	19	15	AS 22
9287 E	1	33,0	140	M 30 x 1 L	25	22	18	AS 25
9289 E	1	33,6	140	M 30 x 1	25	22	18	GS 25
<b>9316 E</b>	1	40,0	136	M 38 x 1,5 L	32	27	22	AS/AV 32
9335 E	1	41,2	136	M 39 x 1 R o. L	35	30	24	GM 32 erw. 35 - GM35
9336 E	1	41,5	136	M 38 x 1,5 R o. L	32	27	22	GM 32
<b>9333 E</b>	1	45,0	136	M 42 x 1,5 L	35	30	24	GM 35
9374 E	1	51,5	136	M 48 x 1,5	42	36	28	GM 42
9368 E	1	57,0	160	M 54 x 1,5 L	48	41	33	AS/AV/AA/AR 48
<b>9401 E</b>	1	60,0	160	M 57 x 1,5 L	50	43	35	GS 50 - GS 51
<b>9447 E</b>	1	77,5	170	M 74 x 1,5 L	67	58	47	AS 67
<b>9475 E</b>	1	94,0	180	M 88 x 1,5 L	82	70	57	AS/AV 82
<b>9483 E</b>	1	114,0	235	M 108 x 1,5 L	100	87	71	AS 100

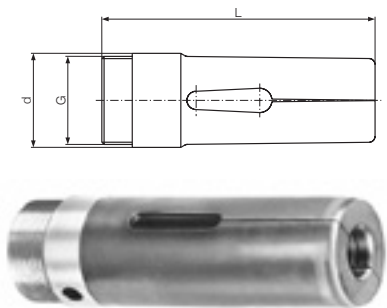

Pic. 1

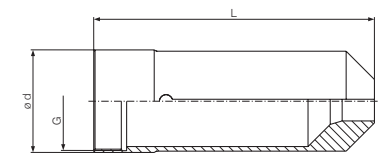

Pic. 2

### for Index

art. no.	pic.	d	L	thread G	max. diameter			type
					○	⬡	□	
<b>9255 E</b>	1	25	88	M 23 x 1	19	16	13	MS 16
9273 E	1	30,8	102	M 28 x 1,5 R o. L	22	19	15	KS 20 - KS 22
<b>9282 E</b>	1	35 (37)	118	M 33 x 1,5	25	22	18	KS/MS 25
9319 E	1	41,8	130	M 38 x 1,5	32	28	23	KS 32
<b>9333 E</b>	1	45	136	M 42 x 1,5 L	35	30	24	MS 35
9364 E	1	54	170	M 50 x 1,5 L	42	36	30	KS 42
9402 E	1	60	156	M 57 x 2 L	50	43	35	KS 50
<b>9401 E</b>	1	60	160	M 57 x 1,5 L	50	43	35	MS 50

### for Pittler

art. no.	pic.	d	L	thread G	max. diameter			type
					○	⬡	□	
9278 E	1	35,0	147	1.1/4" x 1/20" L	25	22	18	PRC 25
9285 E	1	39,5	168	1.7/16" x 1/20" L	32	27	22	PRB/PRC 32
9330 E	1	44,3	168	1.5/8" x 1/20" L	36	31	25	PRC 36
9405 E	1	63,5	186	2.5/16" x 1/24" L	50	43	35	PRB/PRC 50
9472 E	1	92,0	214	3.3/8" x 1/24" L	72	62	51	PRC 72
9482 E	1	116,0	273	4.3/8" x 1/18" L	104	90	73	PRC 100

## COLLETS FOR MULTI-SPINDLE AUTOMATIC LATHES

### for Schütte

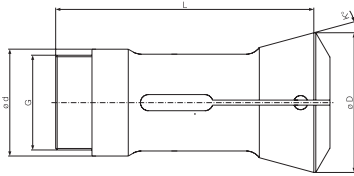

Pic. 1

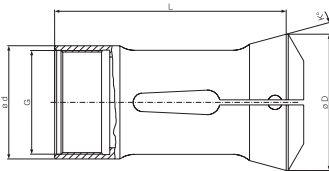

Pic. 2

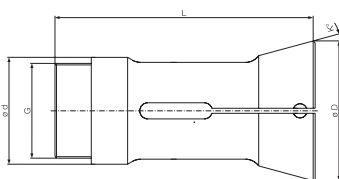

Pic. 3

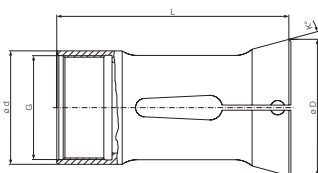

Pic. 4

art. no.	pic.	d	D	L	K°	thread G	max. diameter			type
							○	⬡	□	
9015 E	1	25	36,1	68	15	M 22 x 1 L	13	11	9	SF 12 - SF 13
9006 E	3	30	40,5	80	15	M 26 x 1 L	16	14	11	SB 16
9007 E	1	32	41,5	79	15	M 28 x 1 L	16	14	11	SE 16 - SE 18
9016 E	1	32	41,5	79	15	M 30 x 1 L	20	17	14	SF/VD 20
9049 E	1	46	60,3	112	15	M 40 x 1,5 L	25	22	18	AF/SE/SD/VD 25 - SF 26
9070 E	1	53	69,3	128	15	M 47 x 1,5 L	32	28	23	AF/AV/SF/SD/VD 32
9083 E	1	56	72,5	130	15	M 52 x 1,5 L	36	31	25	S 36 PC
9112 E	1	62,9	78,3	147	15	M 56 x 1,5 L	40	35	28	SD/SF 40 - SF 42
9139 E	1	75	97,8	175	15	M 68 x 1,5 L	50	43	35	SD/SF 50 - SF 51 - S 51 PC
9179 E	1	90	115,3	200	15	M 82 x 1,5 L	63	54	44	SD/SF/VD 63
9187 E	2	89,9	115,3	172	15	M 85 x 1,5 L	69	59	48	SF 67
9210 E	1	109	138,3	230	15	M 100 x 1,5 L	63	54	44	SD 80/SF 81

### for Tornos

art. no.	pic.	d	D	L	K°	thread G	max. diameter			type
							○	⬡	□	
9001 E	2	25	35	73	15°30'	M 22 x 1	14	12	10	AS/BS 14
9021 E	1	25	35	92	15°30'	M 25 x 1	16	14	11	AS/SAS 16
9018 E	1	35	45	105	15°30'	M 33 x 1	23	20	16	BS 20/22
9020 E	2	36	45	105	15°30'	M 33 x 1,25	21	18	14	BS 20 B

### for Tornos Bechler

art. no.	pic.	d	D	L	K°	thread G	max. diameter			type
							○	⬡	□	
9012 E	1	34	4,0	85	16	M 30 x 1 L	20	17	14	Multi Deco 20-6, 20-8
9049 E-1	1	46	60,3	112	15	M 40 x 1,5 L	25	22	18	Multi Deco 26-6

### for Wickmann

art. no.	pic.	d	D	L	K°	thread G	max. diameter			type
							○	⬡	□	
9014 E	4	29,4	38,1	90,5	15	1.03" x 1/24" L	16	13	11	5/8"
9034 E	2	41,0	54,5	130,2	15	1.484" x 1/24" L	25	22	17	1"
9072 E	2	55,0	66,8	113,5	16	2.001" x 1/22"	32	27	22	1.3/8"
9111 E	2	64,21	78,7	127,0	15	2.376" x 1/16"	45	27	22	1.3/4"

### for ZPS

art. no.	pic.	d	D	L	K°	thread G	max. diameter			type
							○	⬡	□	
9047 E	2	42,0	50,0	120	15	M 38 x 1,5	25	22	17	SAY - 25
9049 E	1	46,0	60,3	112	15	M 40 x 1,5 L	25	22	17	SAY - 25
9070 E	1	53,0	69,3	128	15	M 47 x 1,5 L	32	28	23	SAY - 32
9112 E	1	62,90	78,3	147	15	M 56 x 1,5 L	40	35	28	SAY - 42

Highlighted art. no. according to VDI 3322

## FEED FINGERS FOR MULTI-SPINDLE AUTOMATIC LATHES

### for Schütte

art. no.	pic.	d	L	thread G	max. diameter			type
					○	⬡	□	
9261 E	1	19,6	82	M 18 x 1	13	11	9	SF 12 - SF 13
9254 E	1	23	88	M 21 x 1 R o. L	16	14	11	SB 16
9255 E	1	25	88	M 23 x 1	19	16	13	SE 16 - SE 18
9262 E	1	27	88	M 25 x 1	20	17	14	SF/VD 20
9282 E	1	35 (37)	118	M 33 x 1,5	25	22	18	AF/SE/SD/VD 25 - SF 26
9319 E	1	41,8	130	M 38 x 1,5	32	28	23	AF/AV/SF/SD/VD 32
9333 E	1	44	136	M 42 x 1,5 L	36	31	25	S 36 PC
9372 E	1	51	174	M 48 x 1,5	40	35	28	SD/SF 40 - SF 42
9406 E	1	62 (64)	195	M 58 x 1,5	50	43	35	SD/SF 50 - SF 51 - S 51 PC
9450 E	1	77	205	M 72 x 1,5 L	63	54	44	SD/SF/VD 63
9456 E	2	78	225	M 75 x 1,5 L	69	59	48	SF 67
9474 E	1	92,8	233	M 88 x 1,5 L	80	69	56	SD 80/SF 81

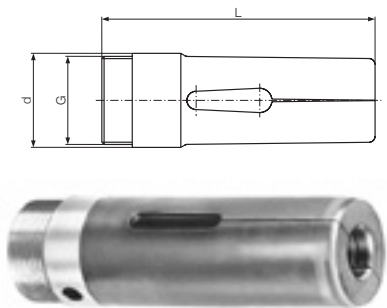

Pic. 1

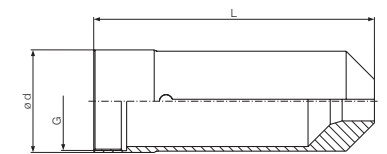

Pic. 2

### for Tornos

art. no.	pic.	d	L	thread G	max. diameter			type
					○	⬡	□	
9251 E	1	17,9	70	M 16 x 0,75	14	12	10	AS/BS 14
9251 E-1	1	18,3	70	M 17 x 0,75	15	13	10	AS/BS 14
9265 E	1	22,8	98	M 20 x 0,75	16	14	11	AS/SAS 16
9266 E	1	27,7	116	M 25 x 1	21	18	14	BS 20 B
9263 E	1	29,7	116	M 27 x 1	23	20	16	BS 20/22

### for Tornos Bechler

art. no.	pic.	d	L	thread G	max. diameter			type
					○	⬡	□	
9258 E	1	25	90	M 24 x 1	20	17	14	Multi Deco 20-6, 20-8
9282 E	1	35 (37)	118	M 33 x 1,5	25	22	18	Multi Deco 26-6

### for Wickmann

art. no.	pic.	d	L	thread G	max. diameter			type
					○	⬡	□	
9260 E	1	21,5	85,5	0.771" x 1/24" L	16	13	11	5/8"
9276 E	1	31,9	133,4	1.184" x 1/24" L	26	22	17	1"
9318 E	1	42,6	117,5	1.593" x 1/22" L	32	27	22	1.3/8"
9362 E	1	52,2	127,0	1.968" x 1/22" L	45	38	31	1.3/4"

### for ZPS

art. no.	pic.	d	L	thread G	max. diameter			type
					○	⬡	□	
9290 E	1	32,0	115	M 30 x 1 L	25	22	18	SAY - 25
9282 E	1	35 (37)	118	M 33 x 1,5	25	22	18	SAY - 25
9319 E	1	41,8	130	M 38 x 1,5	32	28	23	SAY - 32
9372 E	1	51,0	174	M 48 x 1,5	40	35	28	SAY - 42

Highlighted art. no. according to VDI 3322



## PICK-UP COLLETS FOR MULTI-SPINDLE AUTOMATIC LATHES

### for Gildemeister

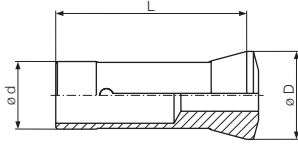

Pic. 1

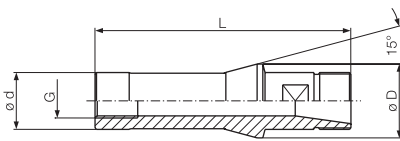

Pic. 2

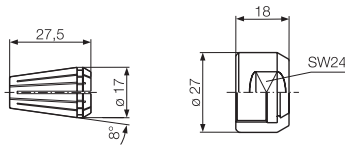

Pic. 3

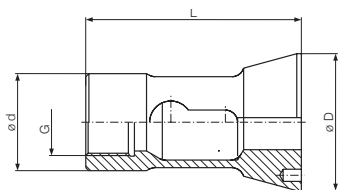
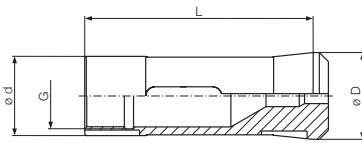

Pic. 4



art. no.	pic.	d	D	L	thread G	type
3439 E	9	18,7	25,0	48,5	bayonet	GM 16 AC
1292 E	1	20	26,0	56,5		AS/GS 20 - pick-up collet
3560 E	3	26	28,5	75	M 21,5 x 0,75	AS 16/20 - GS 20
3655 E	3	30	35,1	62	M 20 x 1,5	AS 16/20 - AS 22/25
3762 E	4	38	43,1	80	M 24 x 1,5	AV/AS/GS 32 - GS 36/42
3865 E	10	47	52,5	68	bayonet	GM 42
3939 E	4	60	105,0	130	M 40 x 1,5	AV/AS 82
3940 E	4	60	120,1	130	M 40 x 1,5	AS 100

### collet chuck for Gildemeister

art. no.	pic.	d	D	L	thread G	type
1292 E-F	2	20	26	90	M 20 x 1	AS/GS 20

### for Schütte

art. no.	pic.	d	D	L	thread G	type
3380 E	4	20	24,0	38,3	M 16 x 1,5 L	SF 13
3540 E	4	25	35,1	57	M 18 x 1,5 L	SE 16 - SE 18
3607 E	4	28	36,0	48	M 24 x 1,5 L	SF 20 L
3722 E	4	32	45,1	69,5	M 22 x 1,5 L	SD/SE/VD 25 - SK 26
1495 E	5	34	42,0	52		SE/SF 26 - AF 40
3790 E	4	39	50,6	79	M 26 x 1,5 L	SD/VD 32
1631 E	8	44	54,1	71		S 36 PC
1700 E	5	52	60,6	60		SF/AF 32 - SF 40 - SF 42
3863 E	4	46	67,2	81,5	M 32 x 1,5 L	SD/VD 50
1739 E	8	59	67,0	69		S 51 PC
1777 E	5	63	71,6	60		SF/AF 51
1843 E	5	76	88,0	75		SF/AF 67 - SF 81
3914 E	4	55	88,9	90	M 42 x 1,5 L	VD/SD 63
3917 E	4	55	108,0	90	M 42 x 1,5 L	VD/SD 80

**for Tornos**

art. no.	pic.	d	D	L	thread G	type
3263 E	6	16	21	66	M 14 x 0,75	AS 14 - SAS 16
3541 E	7	25	35	77	M 22 x 1	BS 20 B

**for Tornos Bechler**

art. no.	pic.	d	D	L	thread G	type
3601 E	10	28,0	32	68	bayonet	Multi Deco 20 - 6, 20 - 8
3757 E	10	35,5	40	75	bayonet	Multi Deco 26 - 6, 32 - 6

**for Wickman**

art. no.	pic.	d	D	L	thread G	type
1261 E	8	19,0	26	55,6		5/8"
1381 E	8	25,4	38	93,6		1"
1561 E	8	39,7	65	120,6		1.3/8" - 1.3/4"

**for ZPS**

art. no.	pic.	d	D	L	thread G	type
3756 E	3	35,5	40	80,0	M 25 x 1	SAY 6/25 - SAY 6/32
1525 E	5	36,0	45	61,5		SAY 6/25 - SAY 6/32
1621 E	1	42,0	54	78,5		SAY 6/42

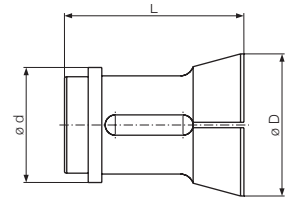

Pic. 5

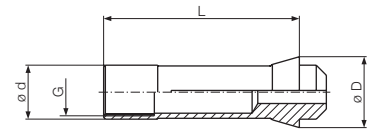

Pic. 6

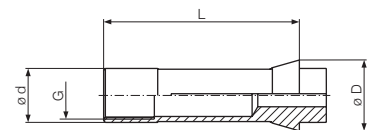

Pic. 7

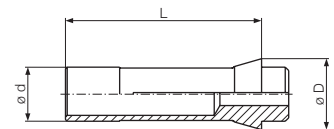

Pic. 8

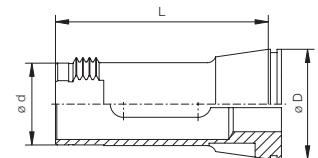

Pic. 9

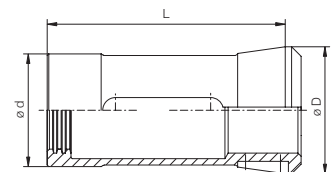

Pic. 10

## CLAMPING HEADS FOR MULTI-SPINDLES

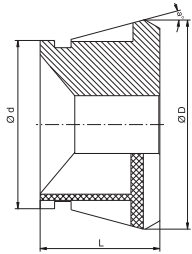

Pic. 1

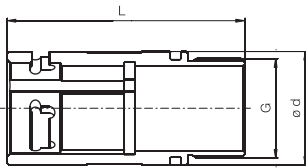

Pic. 2

### for INDEX

art. no.	id.	pic.	d	D	L	thread	max. diameter			type
							○	⬡	□	
9539 E	Clamping head	1	37,5	60,5	38		26	22	18	MS 25
	Basic body	2	46		93,5	M 40 L	26	22	18	
9542 E	Clamping head	1	47,2	61	47		32	27	22	MS 32
	Basic body	2	46			M 42 x 1,0 L	32	27	22	
782 E	Clamping head	1	54	79,5	47		42	36	30	MS 36 - MS 42
	Basic body	2	56		111,7	M 52 x 1,5 L	42	36	30	

### for Tornos Bechler

art. no.	id.	pic.	d	D	L	thread G	max. diameter			type
							○	⬡	□	
9542 E	Clamping head	1	47,2	61	47		32	27	22	Multi Deco 26 - 6
	Basic body	2	46,0		81,5	M 42 x 1,0 L	32	27	22	

### for Schütte

art. no.	id.	pic.	d	D	L	thread G	max. diameter			type
							○	⬡	□	
9507 E	Clamping head	1	29,6	42,5	28		18	15	13	SG 18 - AG 20
	Basic body	2	32		67	M 28 x 1 L	18	15	13	
9539 E	Clamping head	1	47,5	60,5	38		26	22	18	SE 25 - SE/AF/ SF 26 - SF 26S
	Basic body	2	46		93,5	M 40 L	26	22	18	
9550 E	Clamping head	1	54	78,3	47		42	36	30	AD/SF 40 - AD/SF 42
	Basic body	2	63		119	M 56 x 1,5 L	42	36	30	
9564 E	Clamping head	1	66	98,2	65		50	41	34	SD 50 - AS/SF 51 - SF 51S
	Basic body	2	75		187	M 68 x 1,5 L	50	41	34	

### for Gildemeister

art. no.	id.	pic.	d	D	L	thread G	max. diameter			type
							○	⬡	□	
9506 E	Clamping head	1	29	42,3	29		20	17	14	AS/GM/GS 20 - AS 16
	Basic body	2	34		85,5	M 30 x 1 L	20	17	14	
9508 E	Clamping head	1	23	45,5	29		25	21	17	AS 20 - 25
	Basic body	2	38		90	M 34,5 x 0,75 L	25	21	17	
9545 E	Clamping head	1	44,5	69,4	43		32	28	22	AS/GM/GS 32
	Basic body	2	53		128	M 68 x 1,5 L	32	28	22	

### for Mori Say

art. no.	id.	pic.	d	D	L	thread G	max. diameter			type
							○	⬡	□	
9550 E	Clamping head	1	54	78,3	47		42	36	30	6/32 M - 6/42 CNC
	Basic body	2	63		119	M 56 x 1,5 L	42	36	30	

## CLAMPING HEADS

### Use:

- for workpiece clamping
- for bar or chuck work
- for standard chucks

### Patterns:

- long version
- short version
- unhardened bore and plane surface

### Bore patterns:

- (G): smooth  
 (LQ): serrated  
 (Q): with round grooves  
 (W): unhardened, ca. 42 HRC

### size 32

art. no.	D	L	bore pattern			max. diameter			pitch
			LQ	Q	G	○	⬡	□	
772 E	SK 32	57,7	47		*	4 - 7 mm			1,0
772 E	SK 32	57,7	47		*	8 - 10 mm			1,0
772 E	SK 32	57,7	47	*		11 - 32 mm			1,0
772 E	SK 32	57,7	47		*		7 mm	7 mm	1,0
772 E	SK 32	57,7	47		*		8 - 27 mm	8 - 22 mm	1,0
771 E	SK 32 G	57,7	44		*	4 - 32 mm			1,0
771 E	SK 32 W	57,7	44		*	5, 15, 20 mm			1,0

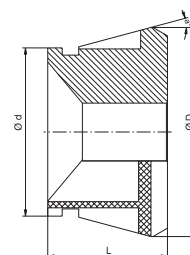

### size 42

art. no.	D	L	bore pattern			max. diameter			pitch
			LQ	Q	G	○	⬡	□	
782 E	SK 42	79,5	47		*	4 - 7 mm			0,5
782 E	SK 42	79,5	47		*	8 - 10 mm			0,5
782 E	SK 42	79,5	47	*		11 - 42 mm			0,5
782 E	SK 42	79,5	47		*		7 mm	7 mm	1,0
782 E	SK 42	79,5	47		*		8 - 36 mm	8 - 30 mm	1,0
781 E	SK 42 G	79,5	42		*	4 - 42 mm			0,5
781 E	SK 42 W	79,5	42		*	8, 15, 30 mm			

Pic. 1



### size 52

art. no.	D	L	bore pattern			max. diameter			pitch
			LQ	Q	G	○	⬡	□	
783 E	SK 52	79,5	46		*	4 - 7 mm			0,5
783 E	SK 52	79,5	46		*	8 - 10 mm			0,5
783 E	SK 52	79,5	46	*		11 - 52 mm			0,5
783 E	SK 52	79,5	46		*		7 mm		
783 E	SK 52	79,5	46		*		8 - 45 mm	8 - 36 mm	1,0
783 E	SK 52 G	79,5	46		*	4 - 52 mm			0,5
783 E	SK 52 W	79,5	46		*	8, 15, 30 mm			

Attachments for turning inside diameters of unhardened clamping heads on request

## CLAMPING HEADS

### Use:

- for workpiece clamping
- for bar or chuck work
- for standard chucks

### Bore patterns:

- (G): smooth
- (LQ): serrated
- (Q): with round grooves
- (W): unhardened, ca. 42 HRC

### Patterns:

- long version
- short version
- unhardened bore and plane surface

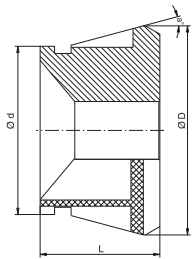

### size 65

art. no.	D	L	bore pattern			max. diameter			pitch
			LQ	Q	G	○	⬡	□	
788 E	SK 65	99,5	58		*	4 - 7 mm			0,5
788 E	SK 65	99,5	58		*	8 - 10 mm			0,5
788 E	SK 65	99,5	58	*		11 - 65 mm			0,5
788 E	SK 65	99,5	58		*		7 mm		
788 E	SK 65	99,5	58		*		8 - 56 mm	8 - 46 mm	1,0
787 E	SK 65 G	99,5	53		*	4 - 65 mm			0,5
787 E	SK 65 W	99,5	53		*	8, 20, 40 mm			

### size 80

art. no.	D	L	bore pattern			max. diameter			pitch
			LQ	Q	G	○	⬡	□	
791 E	SK 80	114,5	53		*	8 - 10 mm			1,0
791 E	SK 80	114,5	53	*		11 - 80 mm			1,0
791 E	SK 80	114,5	53		*		8 - 68 mm	8 - 56 mm	1,0
791 E	SK 80 G	114,5	53		*	8 - 80 mm			1,0
791 E	SK 80 W	114,5	53		*	20, 40, 60 mm			

### size 100

art. no.	D	L	bore pattern			max. diameter			pitch
			LQ	Q	G	○	⬡	□	
797 E	SK 100	144,5	59	*		42 - 100 mm			1,0
797 E	SK 100	144,5	59		*		50 - 86 mm	50 - 70 mm	1,0
797 E	SK 100 G	144,5	59		*	42 - 100 mm			1,0
797 E	SK 100 W	144,5	59		*	30, 45, 65, 90 mm			



**size 120**

art. no.		D	L	bore pattern			max. diameter			pitch
				LQ	Q	G	○	⬡	□	
798 E	SK 120	180,0	61	*			62 - 120 mm			1,0
798 E	SK 120	180,0	61		*			50 - 104 mm	50 - 85 mm	1,0
798 E	SK 120 G	180,0	61			*	62 - 120 mm			1,0
798 E	SK 120 W	180,0	61			*	65, 90, 110 mm			

Attachments for turning inside diameters of unhardened clamping heads on request

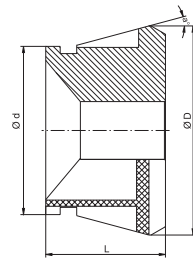

**size 140**

art. no.		D	L	bore pattern			max. diameter			pitch
				LQ	Q	G	○	⬡	□	
796 E	SK 140	195,6	63	*			140 mm			1,0
796 E	SK 140	195,6	63		*			121 mm	98 mm	1,0



**size 160**

art. no.		D	L	bore pattern			max. diameter			pitch
				LQ	Q	G	○	⬡	□	
799 E	SK 160	225,5	63	*			160 mm			1,0
799 E	SK 160	225,5	63		*			138 mm	113 mm	1,0

These clamping heads are completely vulcanised; design with rubber inserts not possible

**changing fixtures for clamping heads**

art. no.	pic.
SK 32 WVM	1
SK 32 WVP	2
SK 42 WVM	1
SK 42 WVP	2
SK 65 WVM	1
SK 65 WVP	2
SK 80 WVM	1
SK 80 WVP	2
SK 100 WVM	1
SK 100 WVP	2



Pic. 1

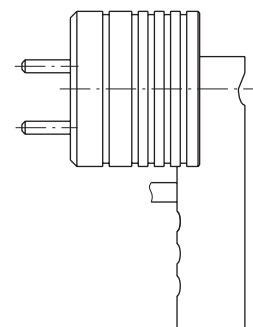

Pic. 2

## DRAW-BACK COLLETS

### Use:

- for workpiece clamping on finishing lathes, grinding machines and indexing units
- small axial movement of the collet during the clamping process
- suitable for very short workpieces, because the power is transferred from the clamping sleeve taper to the taper of the collet on their front part.
- stops can be supplied

### Bore patterns:

smooth

### Mounting sleeves:

Mounting sleeves according to DIN 6341 or something similar are available for the draw-back collets. When making an inquiry or an order, please supply us with details on the mounting taper and type of collet.

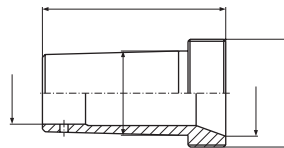

### Taper angle of the clamping sleeve:

The taper of the clamping sleeve should be 15' (one-sided) flatter than the taper angles given in the tables. This frees the collets on release.

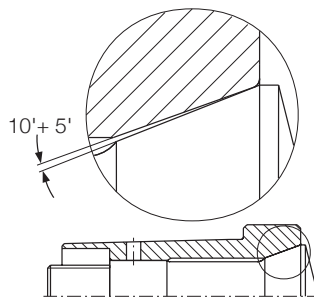

### Hardness:

The collets are made from a special spring steel. Where possible, by partial tempering, the hardness of the taper and clamping bore is approx. HRC 60.

### Taper grinding:

For some types the clamping taper is lightly ground at the slot edges to ease removal of the collet from the mounting taper thus making possible low undersized clamping.

### Extended collets (long-nose collets):

If the collet has to be extended towards the front in order to support the workpiece, it must be ensured that the clamping point reaches into the taper of the collet. If the clamping point lies in front of the collet taper, the nose of the collet will open towards the front. Under these circumstances, running concentricity (truth) will no longer be guaranteed.

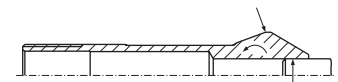

risk of breakage  
collets open to front

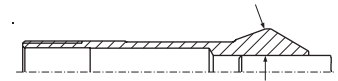

right tension

### Stops for collets:

Adjustable stops which are easily fitted into the rear bore of the collet are available for standard models.

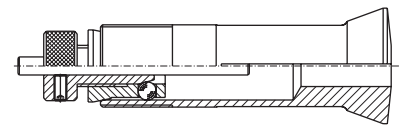

### running concentricity

clamping diameter		testing point	running concentricity	
d from	d to	L	standard	high precision
1	1,6	6	0,02	0,01
1,6	3	10	0,02	0,01
3	6	16	0,02	0,01
6	10	25	0,02	0,01
10	18	40	0,03	0,015
18	24	50	0,04	0,02
24	30	60	0,04	0,02

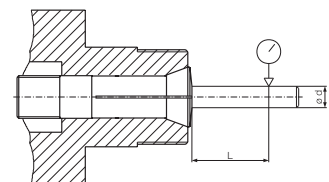

Similar to DIN 6341

## drawback collets

art. no.	pic.	d	D	L	K°	thread G	max. diameter
302 E	1	8	13	34	20	6,85 x 0,625	6
303 E	1	9,3	15	50	21	8,25 x 1/32"	7,5
313 E	1	10	14,5	73	20	M 9,2 x 1	8
314 E	1	10	14	41,5	15	S 9,83 x 0,833	8
318 E	1	12	16	43,5	15	S 11,75 x 1,25	10
<b>319 E</b>	1	12	18	60,0	20	Tr 12 x 1	10
3213 E	1	15	20,2	58,3	15	14,75 x 1,25	12,5
324 E	1	15	21,5	53,0	20	M 13 x 1	13
<b>330 E</b>	1	16	24	70,0	20	Tr 16 x 1,5	13
349 E	1	20	26,3	69,0	15	S 19,7 x 1,667	20
350 E	1	20	27,5	117,0	20	M 18,5 x 1,4	18
<b>351 E</b>	1	20	28	80,0	20	Tr 20 x 1,5	17,5
354 E	1	20	28	117,0	17,5	19 x 1/20"	17,5
355 E	1	20	28	117,5	17,5	S 20 x 2	18
358 E	1	23	32	82,0	20	21,1 x 1	20
<b>359 E</b>	1	23	32	90,0	20	Tr 23 x 1,5	20
369 E	2	24,12	32	101,5	8,5	7/16" x 1/20"	20
363 E	1	25	33,5	84,0	16	M 23 x 1	22
364 E	1	25	34	92,5	15	S 25 x 1/15"	22
366 E	1	28	36	102,0	18	Tr 27 x 1/20"	25
<b>367 E</b>	1	28	38	100,0	20	Tr 28 x 1,5	24
385 E	1	31,75	37,5	83,0	10	31,45 x 1/20"	26
3713 E	1	32	40	100,0	15	S 29,7 x 1/15"	30
<b>386 E</b>	1	32	45	110,0	20	Tr 32 x 1,5	29
3838 E	1	45	53	109,0	15	M 42 x 1,5	40
<b>389 E</b>	1	45	60	140,0	20	Tr 45 x 2	40
390 E	1	47	60	110,0	20	Tr 47 x 1,5	42

Highlighted art. no. according to DIN 6341

## type NK

art. no.	d	D	L	K°	thread G	max. diameter
637 E	16	24,5	58,0	24	M 16 x 1	12
666 E	25	35,5	67,0	20	M 25 x 1	21
667 E	36	46,5	72,5	20	M 36 x 1,5	31
668 E	50	62,5	98,0	20	M 50 x 2	43
669 E	60	73,5	101,0	20	M 60 x 2	52

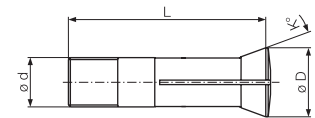

Pic. 1

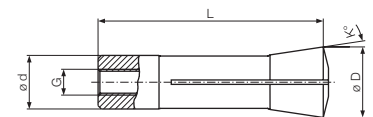

Pic. 2

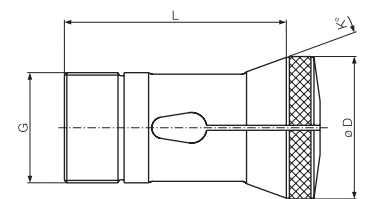

## EMERGENCY COLLETS

### Use:

Emergency collets are used for holding smaller series workpieces when no standard collet is available. Unlike the standard collet, with its hardened taper and clamping bore, emergency collets only have a hardness of approx. HRc 45. The customer can therefore enlarge the bore of the collet.

To enlarge the bore, the emergency collet is clamped on a bolt in the rear of the clamping bore or on pins in the slots and turned out in this position.

### Note:

**The centrifugal force resulting at high speeds can lead to a lessening of the clamping power and, in extreme case, breaking of the collets.**

**Please follow accident-prevention instructions.**

### Special features:

- deadlength collets (**pic. 1**) with a hardness of HRc 45 are available for collet types 140 E, 148 E, 161 E, 163 E, 173 E and 185 E, further types on request.

#### deadlength collets, HRc 45

art. no.	pic.	d	D	L	K°
140 E - 0.0	1	22	30	55	15
148 E - 0.0	1	28	38	70	15
161 E - 0.0	1	32	45	75	15
163 E - 0.0	1	35	48	80	15
173 E - 0.0	1	48	60	94	15
185 E - 0.0	1	66	84	110	15

- deadlength collets (**pic. 2**), short version: see standard collets

- deadlength collets (**pic. 3**), enlarged and extended versions: these deadlength collets are able to clamp large and short workpieces.

#### draw-back collets, HRc 45

art. no.	pic.	D1	L1
Gr. 0.0	2		
Gr. 0.1	3		25
Gr. 1.1	3	40	25
Gr. 1.2	3	40	50
Gr. 2.1	3	50	25
Gr. 2.2	3	50	50
Gr. 3.1	3	75	25
Gr. 3.2	3	75	50
Gr. 4.1	3	100	25
Gr. 4.2	3	100	50

Draw-back collets with a hardness of HRc 45 are available for collet types 349 E, 358 E, 369 E, 363 E, 364 E, 366 E, 367 E, 385 E and 386 E with various head sizes.

Pic. 1

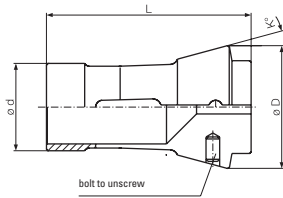

Pic. 2

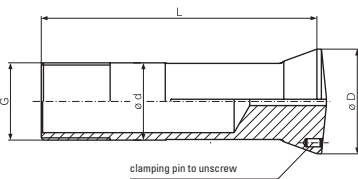

Pic. 3

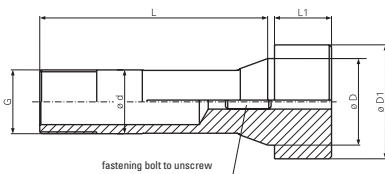

## COLLETS FOR ROTARY TRANSFER MACHINES – HYDROMAT

### Use:

- for workpiece clamping
- no axial movement while chuck is clamping
- suitable for very short workpieces because the power is transferred from the clamping sleeve taper to the taper of the collet on their front part.

### Bore patterns:

smooth

### Hardness:

The collets are made from special spring steel. Where possible, by partial tempering, the hardness of the taper and the clamping bore is HRC 58 - 60.

### Special features:

- the complete set of collets is adjusted in its length
- all collets with high running concentricity
- additional cross keyway in shank on request
- with profiled bored collets, position of shank keyway in relation to profiled bored bore is very important
- square, hex. and other profiled bored bores are eroded – higher running concentricity
- clamping bore expanded by 0.5 mm
- workpiece stops can be supplied

### for Hydromat

art. no.	pic.	d	D	L	K°	thread G	max. diameter
3490 E	2	20	26,3	92,5	15	S 19,7 x 1,667	20,0
3640 E	1	25	33,7	92,5	15	S 24,7 x 1/15"	22,0
	2	25	33,7	92,5	15	S 24,7 x 1/15"	25,0
3714 E	1	32	40	100	15	S 29,7 x 1/15"	32,0
3727 E	2	32	53	116	15	S 29,7 x 1/15"	45,0
3839 E	1	45	53	109	15	M 42 x 1,5	45,0
3854 E	2	45	68	129	15	M 42 x 1,5	55,0

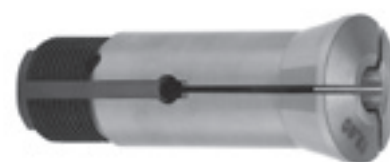
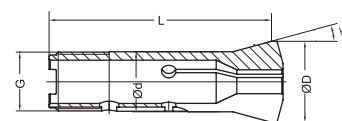

Pic. 1

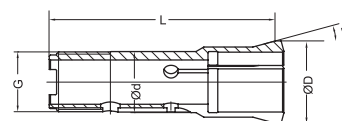

Pic. 2

## DRAW-BACK COLLETS, HIGH PRECISION

### Use:

- for workpiece clamping on tool grinding machines
- small axial movement of the collet during the clamping process
- suitable for very short workpieces, except extended version
- very high running concentricity
- for automatic loading
- all types available in standard length and extended version

### Bore patterns:

smooth

### Hardness:

The collets are made from a special spring steel. Where possible, by partial tempering, the hardness of the taper and clamping bore is approx. HRc 60.

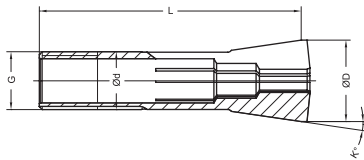

Pic. 1

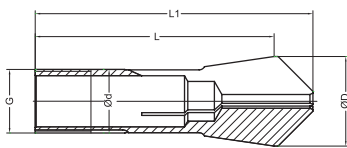

Pic. 2

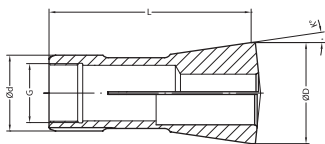

Pic. 3

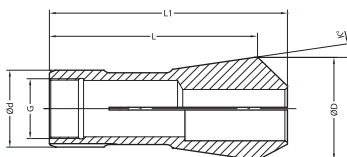

Pic. 4

### high precision

art. no.	pic.	d	D	L	L1 max.	K°	thread G	max. diameter ○	increment
3148 E	1	12	18	63		8° 17'50"	Tr 12 x 1	10,0	0,5
3148 E - V	2	12	18	63	76	8° 17'50"	Tr 12 x 1	10,0	0,5
3409 E	1	20	28	90		8° 17'50"	Tr 20 x 1,5	16,0	0,5
3409 E - V	2	20	28	90	106	8° 17'50"	Tr 20 x 1,5	16,0	0,5
3718 E	1	32	45	120		8° 17'50"	Tr 32 x 1,5	27,0	0,5
3718 E - V	2	32	45	120	148	8° 17'50"	Tr 32 x 1,5	27,0	0,5
3851 E	3	45	60	120		8° 17'50"	Tr 35 x 1,5	36,0	1,0
3851 E - V	4	45	60	120	145	8° 17'50"	Tr 35 x 1,5	36,0	1,0

Collets 3148 E, 3409 E, 3718 E also available with additional internal thread

### running concentricity: draw-back collets, high precision

clamping diameter		testing point	running concentricity
d from	d to	L	standard
1	1,6	5	0,005
1,6	3	10	0,005
3	6	16	0,005
6	10	25	0,005
10	18	30	0,005
18	24	30	0,005
24	36	30	0,005

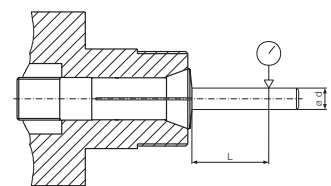

Similar to DIN 6343

## CHUCKS FOR DRAW-BACK COLLETS, HIGH PRECISION

- for draw-back collets, high precision
- simple design
- case hardened
- very high accuracy
- cylindrical fixture
- for spindles with rotating hydraulic or pneumatic cylinders

### chucks

art. no.	pic.	D	D1	L	L1	L2	L3	collets
2.7400.2.001.000	5	18,0	22,0	75,0		7,0	52,0	3148 E
2.7400.2.001.010	5	18,0	22,0	105,0		7,0	82,0	3148 E
2.7400.2.002.000	5	28,0	34,0	75,0		7,0	52,0	3409 E
2.7400.2.002.010	5	28,0	34,0	105,0		7,0	82,0	3409 E
2.7400.2.003.000	5	45,0	52,8	90,0	23,0	30,0	42,0	3718 E
2.7400.2.003.010	5	45,0	52,5	97,0		7,0	74,0	3718 E
2.7400.2.004.000	5	60,0	70,0	105,0	38,0	45,0	44,0	3851 E

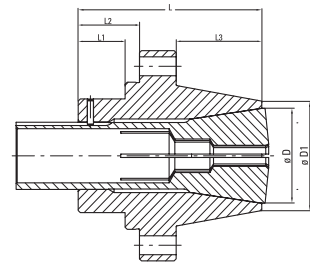

Pic. 5

## TYPE SSF LEVER-OPERATED COLLET CHUCKS



- easily mounted collet chucks for steel and rubber collets
- workpieces can be changed manually during operation
- economical application even for small series
- an all-around multi-purpose chuck of machine tools
- simple balanced design with powertransmission by the means of balls
- excellent clamping power due to optimal power transmission ratio
- workpieces within a tolerance range of IT 9 can be clamped safely
- high precision during constant operation due to hardened parts
- small dimensions and large clamping capacity
- workpieces remain axially stationary during clamping

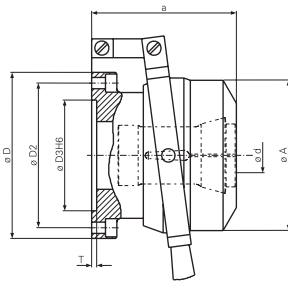

### with cylindrical flange

art. no.	clamping range	D	a	A	D3	fixing screws	D2	steel collets	rubber collets
SSF 16 Z	1 - 16	69	73	66	42	4 x M 5	57	140 E	series 12
SSF 20 Z	2 - 24	88	93	85	54	6 x M 6	74	148 E	series 18
SSF 30 Z	2 - 30	105	106	104	72	6 x M 6	90	163 E	series 24
SSF 40 Z	3 - 42	122	110	129	88	8 x M 6	107	173 E	series 36
SSF 60 Z	4 - 60	150	128	154	115	8 x M 8	131	185 E	series 52
SSF 80 Z	20 - 80	178	150	180	130	8 x M 8	158	193 E	-

Collet chucks are supplied without connecting parts.

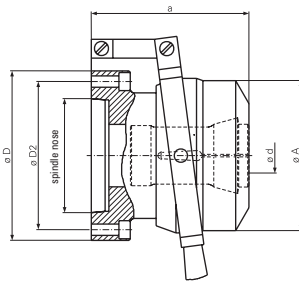

### with flange for spindle-noses

art. no.	clamping range	D	a	A	D3	DIN 55021/22/27/28 Camblok C	fixing screws	D2	steel collets	rubber collets
SSF 30/5	2 - 30	135	120	104	5		4 x M 10	104,8	163 E	series 24
SSF 40/5	3 - 42	135	122	129	5		4 x M 10	104,8	173 E	series 36
SSF 40/C 5	3 - 42	135	123	129		C 5	4 x M 12 x 1,5	104,8	173 E	series 36
SSF 40/6	3 - 42	170	125	129	6		4 x M 12	133,4	173 E	series 36
SSF 40/C 6	3 - 42	170	127	129		C 6	6 x M 16 x 1,5	133,4	173 E	series 36
SSF 60/6	4 - 60	170	140	154	6		4 x M 12	133,4	185 E	series 52
SSF 60/C 6	4 - 60	170	146	154		C 6	6 x M 16 x 1,5	133,4	185 E	series 52
SSF 60/8	4 - 60	220	143	154	8		4 x M 16	171,4	185 E	series 52

Collet chucks are supplied without connecting parts.



## TYPE KSFM POWER-OPERATED COLLET CHUCKS

- for spindles with rotary hydraulic or pneumatic cylinders
- for steel collets
- for rubber collets
- for using two rubber collets – one lies behind the other
- replacement parts for using smaller collets

### with cylindrical flange

art. no.	cyl. size	D1 (mm)	D2 (mm)	D3 (mm)	D4 (mm)	D5 (mm)	L1 (mm)	L2 (mm)	L3 (mm)	L4 (mm)	L5 (mm)	L6 (mm)	speed max (min-1)	steel collets	rubber collets
KSFM 26Z/100	Z 100	112	85	M50 x 1,5	82,6	3 x M10	97,5	24	6	16	8	2	6000	161 E	series 20
KSFM 30Z/100	Z 100	112	85	M50 x 1,5	82,6	3 x M10	97,5	24	6	16	8	2	6000	163 E	series 24
KSFM 40Z/88	Z 88	132	100	M66 x 1,5	115	6 x M8	113,4	17	4	14	8	2,5	6000	173 E	series 36
KSFM 40Z/140	Z 140	155	100	M66 x 1,5	104,8	3 x M10	107,5	17	6	12	8	2,5	6000	173 E	series 36
KSFM 60Z/115	Z 115	154	130	M90 x 1,5	136	8 x M8	127,5	11	4	13	8	2,5	5000	185 E	series 52
KSFM 60Z/170	Z 170	185	130	M90 x 1,5	133,4	6 x M12	133	24	6	18,5	8	2,5	5000	185 E	series 52
KSFM 60Z/220	Z 220	235	130	M90 x 1,5	171,4	6 x M16	135	26	6	20,5	8	2,5	5000	185 E	series 52

### with flange for spindle-noses

art. no.	spindle nose size	D1 (mm)	D2 (mm)	D3 (mm)	D4 (mm)	D5 (mm)	L1 (mm)	L2 (mm)	L3 (mm)	L4 (mm)	L5 (mm)	L6 (mm)	speed max (min-1)	steel collets	rubber collets
KSFM 26/4	A2 - 4	112	85	M50 x 1,5	82,6	3 x M10	103,4	30	13	22	8	2	6000	161 E	series 20
KSFM 30/4	A2 - 4	112	85	M50 x 1,5	82,6	3 x M10	103,4	30	13	22	8	2	6000	163 E	series 24
KSFM 40/5	A2 - 5	135	100	M66 x 1,5	104,8	4 x M10	123,5	27	16	28	8	2,5	6000	173 E	series 36
KSFM 40/6	A2 - 6	170	100	M66 x 1,5	133,4	4 x M12	123,5	34,4	17,5	28	8	2,5	6000	173 E	series 36
KSFM 60/6	A2 - 6	170	130	M90 x 1,5	133,4	4 x M12	145	27	17,5	30,5	8	2,5	5000	185 E	series 52
KSFM 60/8	A2 - 8	220	130	M90 x 1,5	171,4	4 x M16	145,9	37,5	20	31,5	8	2,5	5000	185 E	series 52
KSFM 80/8	A2 - 8	220	156	M114 x 2	171,4	6 x M16	176,4	35	19	41	11	6,5	4000	193 E	

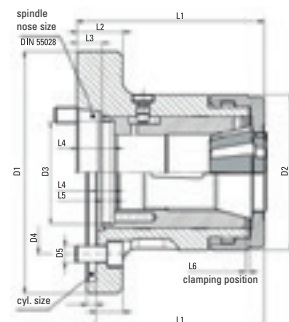

## TYPE KSKF POWER-OPERATED COLLET CHUCKS



The innovative collet chucks feature short changeover times from external to internal clamping and high degrees of precision and rigidity.

- for workpiece clamping of bar and chucking works
- highest clamping forces and rigidity (types KSKF, KSKF-A)
- axially fixed clamping head, less rigidity (type KSKF-AF)
- an intermediate flange is required for all collet chucks type KSKF. Flanges are available in various dimensions and for a variety of spindle noses
- all collet chucks type KSKF are designed in a way that a segment clamping mandrel can be bolt on via the bores at the face end without major modifications of the chuck
- quick change capability of clamping heads

Drawback collet chuck with through-hole for bar machining: the clamping head is pulled into the chuck during clamping and provides high clamping forces and high rigidity.

The collet chucks work very precisely and feature an easy set-up as well as high running accuracy.

**collet chuck type KSKF, drawback collet chuck with through-hole**

art. no.	clamping range	L1	L2	D1	D2	D3	D4	D5	D6	max. speed min <sup>-1</sup>	collet
KSKF 32	4 - 32	70,5	17	137	120	84	70	M8	M54 x 1,5	8.000	771 E, 772 E
KSKF 42	4 - 42	69	17	137	138	104	90	M8	M54 x 1,5	7.000	781 E, 782 E
KSKF 52	4 - 52	72,5	17	155	156	106	92	M8	M74 x 1,5	6.500	783 E
KSKF 65	5 - 65	78	17	155	156	122	110	M8	M74 x 1,5	6.000	787 E, 788 E

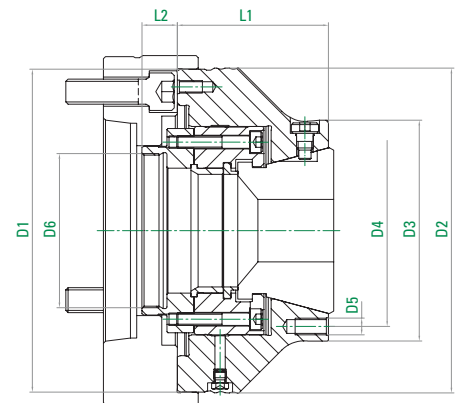

type KSKF

Same as type KSKF, but with an additional stop for chuck parts which can be screwed on: the clamping head offers high clamping forces and high rigidity as well. Due to the

axial pulling effect, the workpiece is pulled against the stop and provides an additional workpiece support. Therefore, the type KSKF-A is perfect with short clamped workpieces.

**collet chuck type KSKF-A, drawback collet chuck with rigid axial stop**

art. no.	clamping range	L1	L2	D1	D2	D3	D4	D5	D6	max. speed min <sup>-1</sup>	collet
KSKF 32-A	4 - 32	70,5	30,5	137	120	84	70	M8	M54 x 1,5	8.000	771 E, 772 E
KSKF 42-A	4 - 42	82,5	17	137	138	104	90	M8	M54 x 1,5	7.000	781 E, 782 E
KSKF 52-A	4 - 52	89	17	155	156	106	92	M8	M74 x 1,5	6.500	783 E
KSKF 65-A	5 - 65	94,5	17	155	156	122	110	M8	M74 x 1,5	6.000	787 E, 788 E

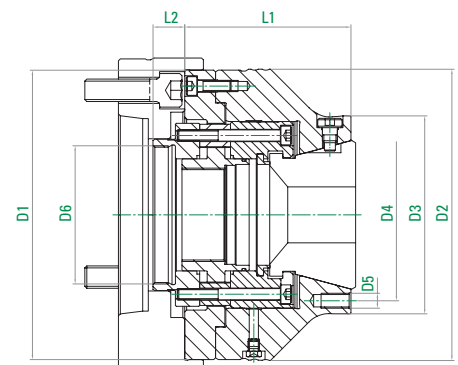

type KSKF-A

Type KSKF-AF is equipped with a fixed clamping head and can be used for through as well as for stop clamping. The pressure sleeve is

pushed over the axially fixed clamping head. Type KSKF-AF offers a lesser stiffness than that achieved with types KSKF and KSKF-A.

**collet chuck type KSKF-AF, fixed clamping head**

art. no.	clamping range	L1	L2	D1	D2	D3	D4	D5	D6	max. speed min <sup>-1</sup>	collet
KSKF 32-AF	4 - 32	80,5	15,5	137	137	105	94	M6	M48 x 1,5	8.000	771 E, 772 E
KSKF 42-AF	4 - 42	81	16	137	137	137	120	M8	M54 x 1,5	7.000	781 E, 782 E
KSKF 52-AF	4 - 52	92,5	17	155	155	155	138	M8	M74 x 1,5	6.500	783 E
KSKF 65-AF	5 - 65	92,5	17	155	155	155	138	M8	M74 x 1,5	6.000	787 E, 788 E

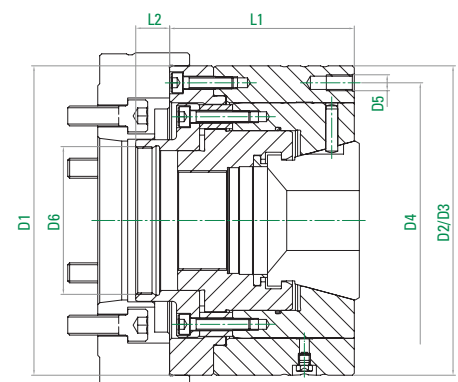

type KSKF-AF

## INTERMEDIATE FLANGES

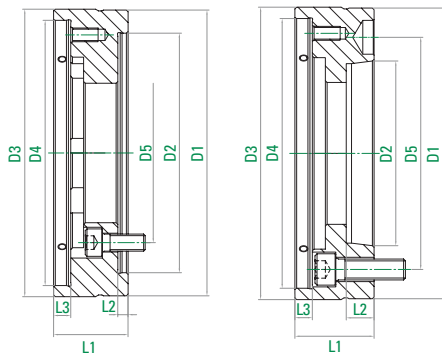

Intermediate flanges

The intermediate flanges match the collet chuck types KSKF, KSKF-A und KSKF-AF. Explanation first column: Z-140 means cylindrical

mount with diameter 140; A-5 means spindle nose with short taper mount size 5 and so on.

### intermediate flanges

art. no.	L1	L2	L3	D1	D2	D3	D4	D5	fastening screw
KSKF 32/42 - Z-140	35,5	6	10	149	140	150	137	104,8	6 x M8
KSKF 32/42 - A-5	44,5	15	10	149	82,563	150	137	104,8	6 x M10
KSKF 32/42 - A-6	45,5	16	10	164	106,375	165	137	133,4	3 x M12
KSKF 52/65 - Z-140	27,5	6	10	167	140	168	155	104,8	6 x M10
KSKF 52/65 - Z-170	32,5	6	10	179	170	180	155	133,4	6 x M12
KSKF 52/65 - A-5	46	15	10	167	82,563	168	155	104,8	6 x M10
KSKF 52/65 - A-6	45,5	16	10	167	106,375	168	155	133,4	3 x M12
KSKF 52/65 - A-8	52	18	10	209	139,719	210	155	171,4	3 x M16



## THROUGH-HARDENED CLAMPING HEADS WITH EXCHANGEABLE RUBBER INSERTS

Nann clamping heads are equipped with rubber inserts making changeover possible on-site: extensive vulcanization is no longer necessary. The collet is ready to be used after 15 minutes – an advantage that proves to be

decisive in practice. The clamping heads can be used for workpiece clamping, chuck and bar work and for all common axial pulling chucks as well.



## TYPE PSF POWER-OPERATED COLLET CHUCKS

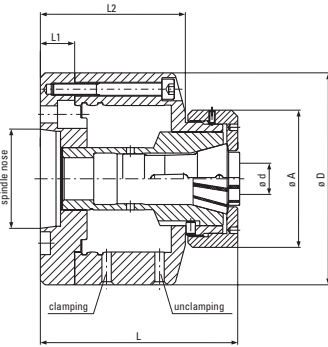

- mechanical power transmission
- high clamping power
- hardened and ground housing
- constant clamping force
- fatigue-proof clamping
- full spindle capacity as the clamping cylinder is integrated in the chuck

The mechanical power transmission is designed in a way that, when clamped, the chucks are self-locking. The self-locking device only operates within a small range. For this reason, only workpieces within range of tolerance group IT 9 can be clamped safely. Due to the self-locking device, compressed air is required for clamping and release.

### Type PSF for operation with a compressed-air gun

The chuck has two holes into which compressed air can be fed from a compressed-air gun for

clamping and release. After the clamping procedure the chuck remains clamped.



art. no.	spindle nose	D	A	L	L1	L2	clamping range	steel collets	rubber collets
PSF 15	Gr. 3 DIN 55026	100	72	126	22	95	1 - 16	140 E	series 12
PSF 25	Gr. 4 DIN 55026	136	88	128	22	93	2 - 26	161 E	series 20
PSF 40	Gr. 5 DIN 55026	160	112	149	25	107	3 - 42	173 E	series 36
PSF 60	Gr. 6 DIN 55026	196	128	159	25	117	4 - 60	185 E	series 52

### Type PSF-SR rotating collet chucks with supply ring

These chucks are equipped with a permanently connected supply ring and sealing through which the compressed air is applied during clamping and unclamping. Clamping can only take place with the spindle stationary as the

seal lies on the chuck body and produces a high degree of friction. For safety reasons an appropriate protective device must be provided.

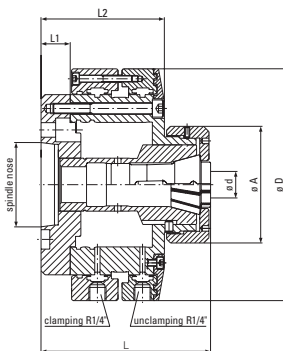

art. no.	spindle nose	D	A	L	L1	L2	clamping range	steel collets	rubber collets
PSF - SR 15	Gr. 3 DIN 55026	140	72	126	22	95	1 - 16	140 E	series 12
PSF - SR 25	Gr. 4 DIN 55026	175	88	128	22	93	2 - 26	161 E	series 20
PSF - SR 40	Gr. 5 DIN 55026	204	112	149	25	107	3 - 42	173 E	series 36
PSF - SR 60	Gr. 6 DIN 55026	250	128	159	25	117	4 - 60	185 E	series 52



## TYPE PSF-ZT POWER-OPERATED COLLET CHUCKS

- high clamping power without clamping cylinder
- clamping via disk springs
- unclamping via compressed air
- permanently connected supply ring for compressed air
- fatigue-proof clamping
- for drawback collets
- simple mounting
- for internal clamping too

Because of clamping via disk springs the chuck is always clamped, so the chuck is self-locking. For unclamping compressed air is required. These chucks are equipped with a permanently connected supply ring and sealing through which the compressed air is applied during clamping and unclamping. Clamping can only take place with the spindle stationary as the seal lies on the chuck body and produces a high degree of friction. For safety reasons an appropriate device must be provided.

### with cylindrical flange

art. no.	B	D	A	L	L1	L2	clamping range	collet type
PSF 23 - ZT - Z 42	42	175	42	148	14	95	1,5 - 20	359 E
PSF 28 - ZT - Z 72	72	204	55	156	22	95	1,5 - 24	367 E
PSF 32 - ZT - Z 72	72	204	62	162	22	95	1,5 - 29	386 E
PSF 47 - ZT - Z 88	88	204	80	164	22	95	5,0 - 42	390 E

### with flange for spindle-noses DIN 55026

art. no.	spindle-nose	D	A	L	L1	L2	clamping range	collet type
PSF 23 - ZT - 4	Gr.4 DIN 55026	175	42	156	22	95	1,5 - 20	359 E
PSF 28 - ZT - 4	Gr.4 DIN 55026	204	55	152	20	95	1,5 - 24	367 E
PSF 28 - ZT - 5	Gr.5 DIN 55026	204	55	152	20	95	1,5 - 24	367 E
PSF 32 - ZT - 5	Gr.5 DIN 55026	204	62	160	20	95	1,5 - 29	386 E
PSF 32 - ZT - 6	Gr.6 DIN 55026	204	62	164	24	95	1,5 - 29	386 E
PSF 47 - ZT - 5	Gr.5 DIN 55026	204	80	176	34	95	5,0 - 42	390 E
PSF 47 - ZT - 6	Gr.6 DIN 55026	204	80	176	34	95	5,0 - 42	390 E

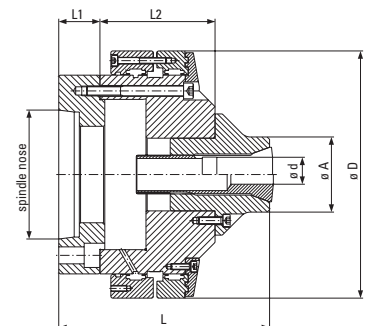
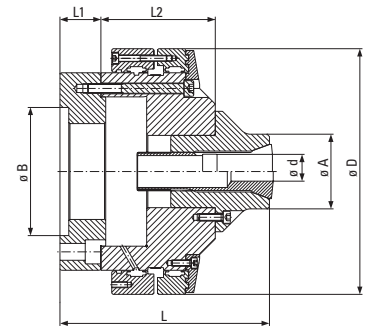

## TYPE HESK, TYPE HESK-R COLLET CLAMPING ATTACHMENTS

- small dimensions
- high clamping power
- absolutely fixed collets
- for 4/2-path valve

Thus, the individual clamping units can be arranged according to requirements. The collets are equipped with a plane shoulder on the thread where they are tightened by means of a nut. That way they are absolutely fixed during clamping, no axial movements are possible.

Type HESK clamping units can be mounted in a housing which is specific to the customer.



art. no.	D	D1	D2	L	L1	L2	B	Tk	collet type
HESK - 20	70	60	70	78,5	58	38	75	82	3723 E
HESK - 30	80	70	80	86,5	58	38	85	92	3829 E
HESK - 40	90	80	90	86,5	88	46	115	122	3911 E
HESK - 60	110	100	110	107,5	88	46	115	122	3964 E

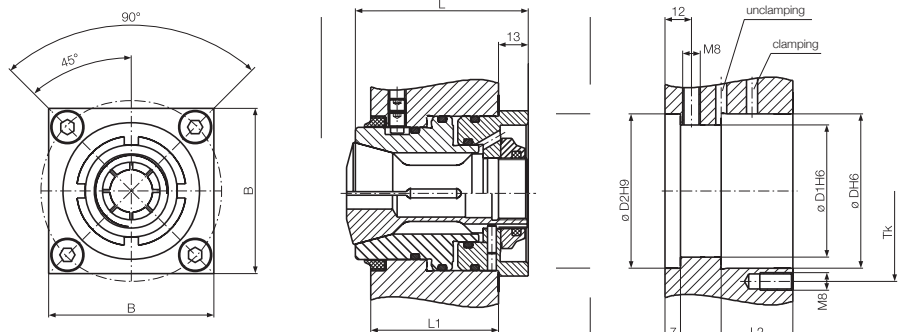

### Type HESK-R

These clamping units correspond to the Type HESK units but without a housing. They are especially used for installation on rotary-

indexing tables. The clamping units can be operated in the loading and unloading station via a controlled rotary transmission.



art. no.	D	D1	D2	L	L1	L2	L3	B	Tk	collet type
HESK - R-20	115	90	86	78,5	38,5	71,5	21,0	96	102	3723 E
HESK - R-30	125	100	96	86,5	38,5	79,5	21,0	106	112	3829 E
HESK - R-40	135	110	106	86,5	38,5	79,5	21,0	116	122	3911 E
HESK - R-60	155	130	126	107,5	46,5	100,0	33,5	136	142	3964 E
HESK - R-100	195	170	168	107,5	46,5	104,2	33,7	176	182	3996 E

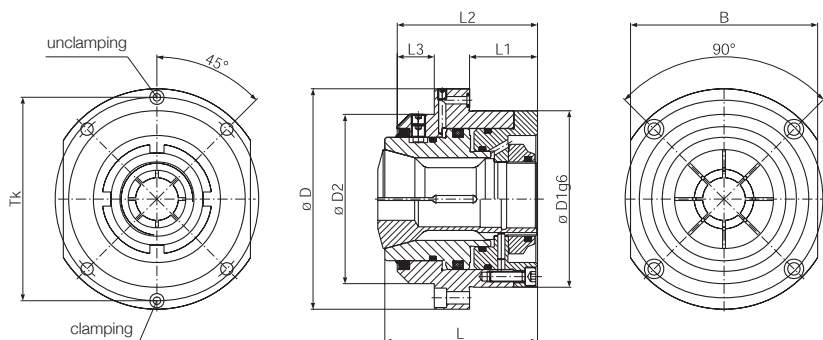



## TYPE HESK-RB COLLET CLAMPING ATTACHMENTS

These clamping attachments are similar to type HESK attachments. The only difference is that we use collets with bayonets. In opposition to clamping attachments type HESK-R the

collet can be changed from front side or from above, therefore the mounting time is reduced to a minimum.

art. no.	D	D1	D2	L	L1	L2	L3	B	Tk	collet type
HESK - RB-20	115	90	86	86,5	38,5	79,5	21,0	96	102	3768 E
HESK - RB-30	125	100	96	86,5	38,5	79,5	21,0	106	112	3859 E
HESK - RB-40	135	110	106	86,5	38,5	79,5	21,0	116	122	3922 E
HESK - RB-60	155	130	126	107,5	46,5	100,0	33,5	136	142	3970 E
HESK - RB-100	195	170	168	107,5	46,5	104,2	33,7	176	182	3999 E

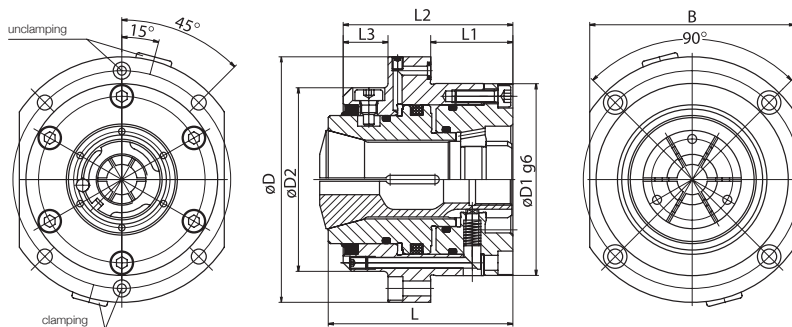

## COLLETS FOR TYPE HESK CLAMPING ATTACHMENTS WITH THREAD

art. no.	id.	A	A1	A2	G	G1	K°	C	C1	max. clamping dia.
3723 E	HESK - S-20	46	22	32	M 32 x 1,5	M 24 x 1,5	15	82	78	22
3829 E	HESK - S-30	56	32	42	M 42 x 1,5	M 34 x 1,5	15	90	86	32
3911 E	HESK - S-40	66	42	52	M 52 x 1,5	M 44 x 1,5	15	90	86	42
3964 E	HESK - S-60	86	62	70	M 70 x 1,5	M 65 x 1,5	15	111	107	62
3996 E	HESK - S-100	126	102	110	M 110 x 2,0	M 104 x 1,5	15	111	107	110

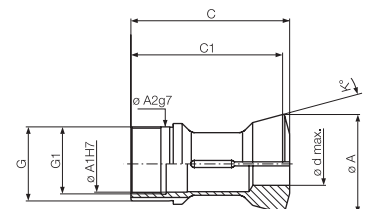

## COLLETS FOR TYPE HESK-RB CLAMPING ATTACHMENTS WITH BAYONET

art. no.	id.	A	A1	A2	G	G1	K°	C	C1	max. clamping dia.
3768 E	HESK - SB-20	46	22	35,8	M 24 x 1,5		15	90	86	22
3859 E	HESK - SB-30	56	32	45,8	M 34 x 1,5		15	90	86	32
3922 E	HESK - SB-40	66	42	55,8	M 44 x 1,5		15	90	86	42
3970 E	HESK - SB-60	86	62	75,8	M 64 x 1,5		15	111	107	62
3999 E	HESK - SB-100	100	126	115,8	M 104 x 1,5		15	111	107	110

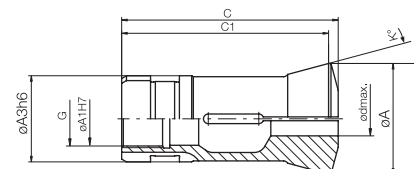

## TYPE HESK-SK COLLET CLAMPING ATTACHMENTS

These clamping attachments are similar to type HESK-R or HESK-RB chucks. The only difference is that we use standard SK clamping heads. The clamping head is absolutely fixed, there is no axial movement. The clam-

ping heads can be changed from the front side or from above, therefore the mounting time is reduced to a minimum.

art. no.	D	D1	D2	L	L1	L2	L3	B	Tk	collet type
HESK - SK - 65	165	140	136	107,5	46,5	100	33,5	146	152	787 E, 788 E

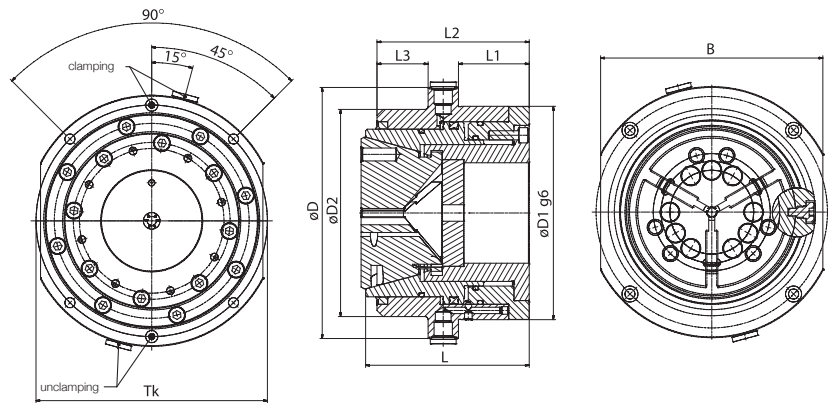

## TYPE HESK-SK-Z COLLET CLAMPING ATTACHMENTS

These clamping attachments are similar to type HESK-SK chucks. The only difference is, that the standard SK clamping head isn't fixed, there is an axial movement of the clamping head. While clamping the workpiece is drawn

into the chuck. The clamping heads can be changed from the front side or from above, therefore the mounting time is reduced to a minimum.

art. no.	D	D1	D2	L	L1	L2	L3	B	Tk	collet type
HESK - SK - 65	165	140	136	107,5	46,5	41		146	152	787 E, 788 E

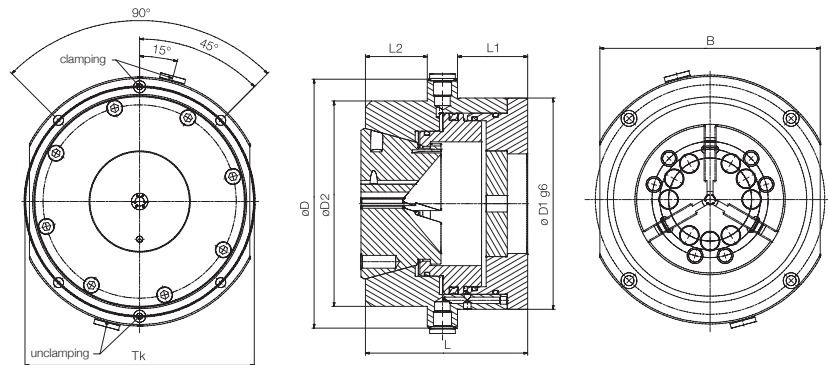

## TYPE HZ HYDRAULIC CLAMPING UNITS

- allows close length tolerances to be reached regardless of variations in the diameter of the workpieces being used
- hydraulic or pneumatic
- direct working pressure sleeve
- tandem cylinder, therefore high clamping power with small dimensions
- hardened and ground housing
- pressure medium can be introduced either over the connection thread or through the mounting plate
- pressure up to 80 bar is possible
- for 4/2-path valve

### for drawback collets (especially suited for applications using short workpieces)

art. no.	A	B	H	piston surface cm <sup>2</sup>	collet typ	through bore	max. clamping dia.	weight kg
HZ 11	80	100	103	40	367 E	22	24	5,0
HZ 17	100	126	115	54	390 E	38	42	7,5
HZ 22	130	166	145	76	3955 E	60	62	17,0

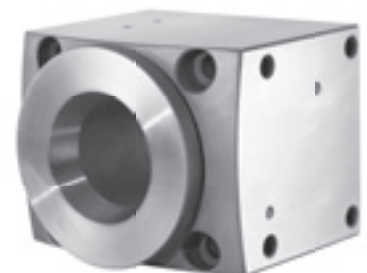
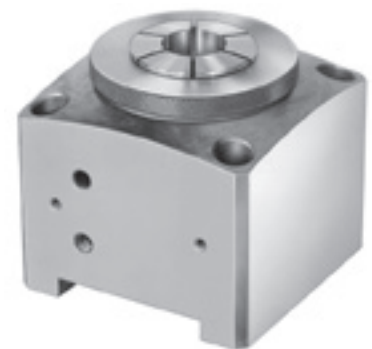
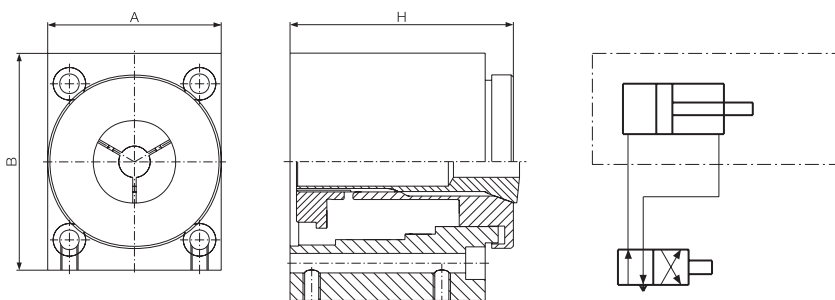

### for deadlength collets (for steel and rubber collets)

art. no.	A	B	H	piston surface cm <sup>2</sup>	collet typ	through bore	max. clamping dia.	weight kg
HZ 25	80	100	107	40	161 E	25	25	5,0
HZ 40	100	126	114	54	173 E	42	42	8,5
HZ 60	130	166	126,5	76	185 E	60	62	16,0
HZ 80	160	190	138	96	193 E	80	80	25,0

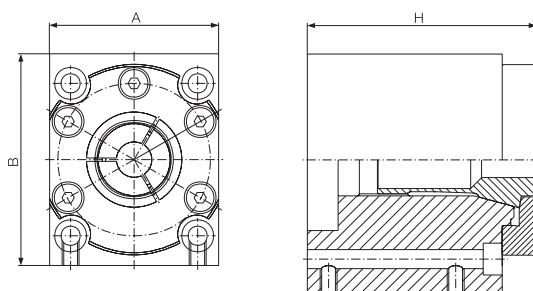

## TYPE HPZ PNEUMATIC CLAMPING UNITS



- drawback collets are especially suited for applications using short workpieces
- allows close length tolerances to be reached regardless of variations in the diameter of the workpieces being used
- mechanical power transmission
- high clamping power
- hardened and ground housing
- suitable for pallets or rotary-indexing tables

pieces within a tolerance range of IT 9 can be clamped safely. When the self-locking feature is set, the collet's axial position will change. This is especially important when several units have been mounted at the same height. In this case stops shouldn't be mounted in the collet. Due to the self-locking device, compressed air is required for clamping and release.

The mechanical power transmission is designed in a way, that when clamped, the chucks are self-locking. Automatic locking only works within a small range. That means only work-

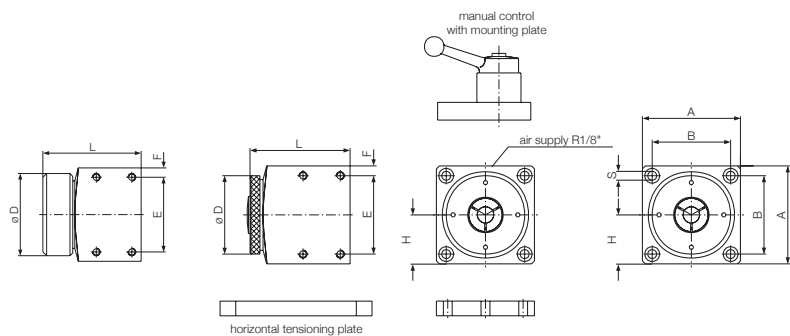

### for drawback collets (especially suited for applications using short workpiece)

art. no.	A	L	H	B	D	E	F	S	collet type	through bore	weight kg
HPZ 11	100	102	50	80	80	80	10	M 8	367 E	22	5,0
HPZ 17	126	119	63	100	100	100	13	M 10	390 E	38	9,0

### for deadlength collets (for steel and rubber collets)

art. no.	A	L	H	B	D	E	F	S	collet type	rubber collets	through bore	weight kg
HPZ 15	80	102	40	60	72	60	10	M 6	140 E	series 12	18	3,5
HPZ 20	100	105	50	80	88	80	10	M 8	148 E	series 18	24	5,0
HPZ 25	100	105	50	80	88	80	10	M 8	161 E	series 20	26	5,0
HPZ 40	126	124	63	100	112	100	13	M 10	173 E	series 36	42	9,5
HPZ 60	166	134	83	126	128	126	20	M 10	185 E	series 52	60	18,0

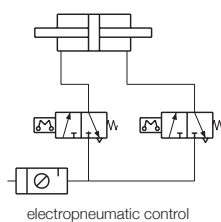
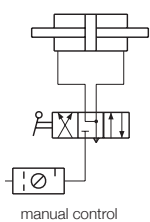

art. no.	clamping power kp	torque at ... $\phi$
HPZ 11	500	50 Nm at 22 $\phi$
HPZ 17	1000	50 Nm at 22 $\phi$
HPZ 25	800	50 Nm at 22 $\phi$
HPZ 40	1500	50 Nm at 22 $\phi$
HPZ 60	2500	50 Nm at 22 $\phi$

### Clamping power:

The clamping power of the type HPZ units is difficult to quote as the clamping effect is dependent on the material, the hardness and the surface of the workpiece. The table therefore gives values for reference purposes only.

## TYPE PS PNEUMATIC CLAMPING UNITS

- drawback collets are especially suited for applications using short workpieces
- allows close length tolerances to be reached regardless of variations in the diameter of the workpieces being used
- can be modified for stepped collets
- integrated 3/2-path control valve remote valves may also be used to open the collet

### for drawback collets



art. no.	a x b	center height H	D	axial height	max. th. bore	max. clamping- $\phi$	collet type	piston surface cm <sup>2</sup>	weight kg
PS 8	85 x 55	70	110	70	8 $\phi$	10 $\phi$ x 30	319 E	47	3,5
PS 9	85 x 55	70	110	80	11 $\phi$	14 $\phi$ x 35	330 E	47	3,5
PS 10	110 x 75	90	140	100	18 $\phi$	20 $\phi$ x 45	359 E	70	8,5
PS 11	110 x 75	90	140	110	22 $\phi$	25 $\phi$	367 E	70	8,5
PS 15	130 x 90	115	190	110	22 $\phi$	25 $\phi$	367 E	168	17,0
PS 17	130 x 90	115	190	120	38 $\phi$	42 $\phi$	390 E	148	19,0

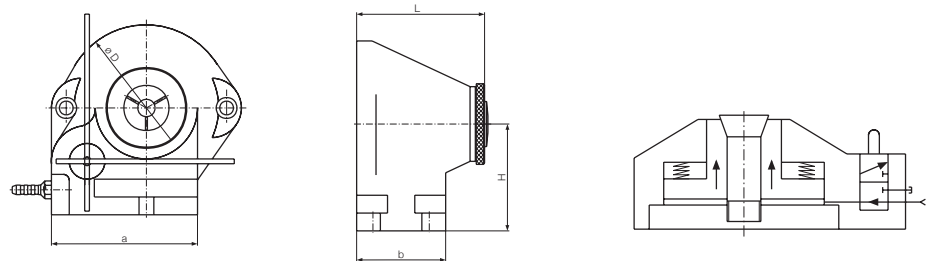

### for deadlength collets



art. no.	a x b	center height H	D	axial height	max. th. bore	max. clamping- $\phi$	collet type	piston surface cm <sup>2</sup>	weight kg
PS 4	85 x 55	70	110	80	12 $\phi$	12 $\phi$	136 E	44	3,5
PS 5	85 x 55	70	110	80	15 $\phi$	15 $\phi$	140 E	44	3,5
PS 13	110 x 75	90	140	105	22 $\phi$	24 $\phi$	148 E	65	8,5
PS 14	110 x 75	90	140	105	26 $\phi$	26 $\phi$	161 E	65	8,5
PS 18	130 x 90	115	190	125	42 $\phi$	42 $\phi$	173 E	148	15,0
PS 19	130 x 90	115	190	125	60 $\phi$	60 $\phi$	185 E	126	16,0

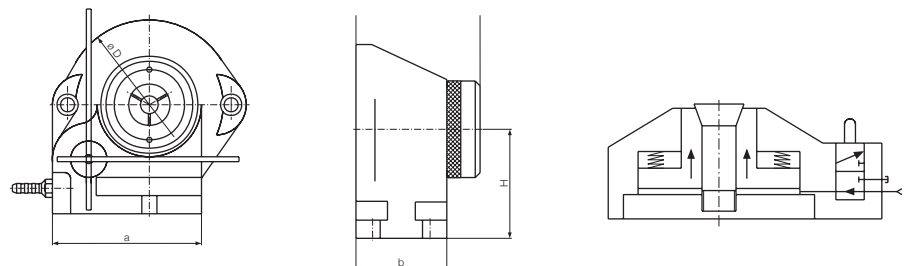

## TYPE MSKZ MANUAL CLAMPING UNITS

- for clamping heads
- easy set-up
- convenient mounting
- horizontal or vertical mounting
- ideal for 5-axis machining
- highest clamping force and rigidity
- pull-down effect
- quick change of clamping heads
- for stationary workpiece stops
- also for use without workpiece top (bore corresponds to the maximum clamping bore of the clamping head)

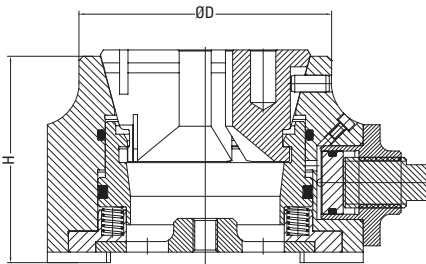

### for clamping heads

art. no.	D	B	L	H	collets
MSKZ 32	80,0	110,0	110,0	100,0	771 E, 772 E
MSKZ 42	100,0	130,0	130,0	100,0	781 E, 782 E
MSKZ 52	100,0	130,0	130,0	100,0	783 E
MSKZ 65	120,0	150,0	150,0	100,0	787 E, 788 E
MSKZ 80	135,0	165,0	165,0	110,0	791 E
MSKZ 100	165,0	200,0	200,0	110,0	797 E

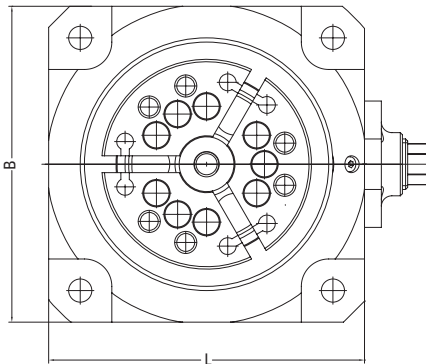

## TYPE MZ MANUAL CLAMPING UNITS



In addition to the advantages of Nann's established clamping units, the manual clamping unit type MZ offers further possibilities. Clamping via clamping heads, deadlength collets, draw-back collets or clamping sleeves is made easy within a short time by replacing

a few components. All this is now made possible through an optimised power transmission in both axial directions and a double-acting piston. The flexible design and comfortable, efficient mounting are further advantages.

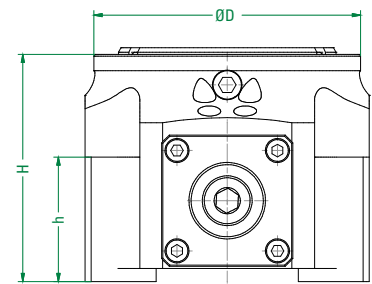
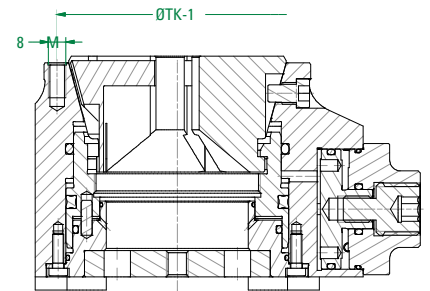

### manual clamping units type MZ

**NEW!**

art. no.	A	B	C	L	h	H	d	D	ØTK-1	ØTK-2	G
MZ 32	80,0	110,0	105,0	145,0	65,0	100,0	100,0	84,0	70,0	66,0	M5
MZ 42	100,0	130,0	117,5	162,0	65,0	100,0	100,0	106,0	92,0	86,0	M5
MZ 52	100,0	130,0	117,5	162,0	65,0	100,0	100,0	106,0	92,0	86,0	M5
MZ 65	112,0	150,0	130,0	176,0	57,0	104,0	104,0	122,0	110,0	107,0	M5
MZ 80	112,0	165,0	142,5	189,7	59,0	104,0	104,0	136,0		125,0	M6

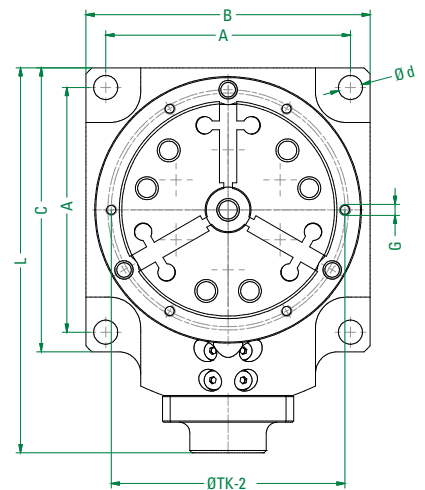

### conversion kits type S, deadlength collets series 100 and draw-back collets series 300

art. no.	H	ØD
MZ32 - S03	168	90
MZ32 - S04	182	90
MZ32 - 140E	141	70
MZ32 - 148E	141	70
MZ32 - 349E	122	80
MZ42 - S04	198	100
MZ42 - 163E	142	80
MZ42 - 364E	122	70
MZ52 - S04	198	100
MZ52 - 148E	140	80
MZ52 - 161E	142	80
MZ52 - 163E	142	80
MZ52 - 359E	122	70
MZ52 - 364E	122	70

art. no.	H	ØD
MZ65 - S04	202	120
MZ65 - 163E	146	80
MZ65 - 173E	150	104
MZ65 - 367E	126	70
MZ65 - 385E	126	70
MZ65 - 386E	136	70
MZ65 - 3713E	126	70

### NEW DEVELOPMENT!

**Interior clamping for clamping chucks**  
 Within a short time, type MZ collet chucks can be converted to interior clamping (see page 41).

## SLEEVE MANDRELS FOR DOUBLE TAPER SLEEVES

Internal clamping sleeves with double taper are suited to internal clamping of pre-machined parts. Because these have tapers and slots at both ends, the clamping sleeve is able

to open in various different ways and securely hold workpieces in the bore which have cylindrical faults.

### type KFD short design

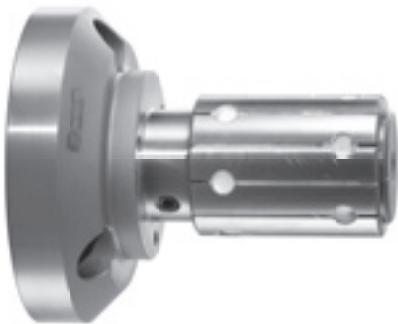

art. no.	clamping range	A	L	Z	B	E	max. tensile force daN
KFD 0 K	15 - 20	102	80	51,5	75	24	400
KFD 1 K	20 - 26	102	88	51,5	75	32	700
KFD 2 K	26 - 34	102	96	51,5	75	40	1100
KFD 3 K	34 - 45	112	106	61	85	50	1600
KFD 4 K	45 - 60	112	121	61	85	65	3000
KFD 5 K	60 - 80	112	146	61	85	90	3000
KFD 6 K	80 - 105	135	182	80	104,8	120	3000
KFD 7 K	105 - 140	135	212	80	104,8	150	3000

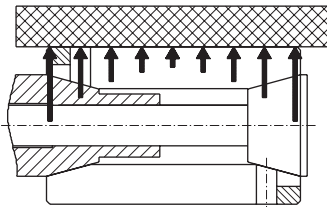
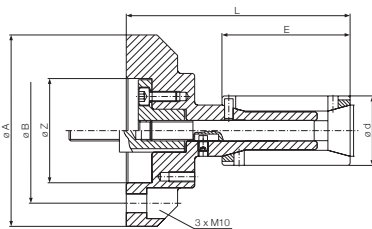

### type KFD long design

art. no.	clamping range	A	L	Z	B	E	max. tensile force daN
KFD 0 L	15 - 20	102	88	51,5	75	32	400
KFD 1 L	20 - 26	102	104	51,5	75	48	700
KFD 2 L	26 - 34	102	116	51,5	75	60	1100
KFD 3 L	34 - 45	112	131	61	85	75	1600
KFD 4 L	45 - 60	112	151	61	85	95	3000
KFD 5 L	60 - 80	112	186	61	85	130	3000
KFD 6 L	80 - 105	135	232	80	104,8	170	3000
KFD 7 L	105 - 140	135	282	80	104,8	220	3000

Adaptor both for manually operated or power driven are not included.

### special design

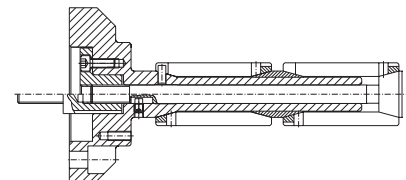
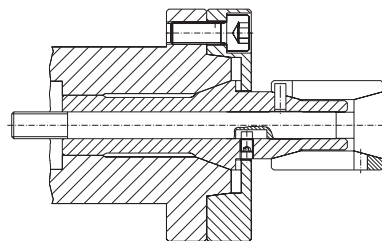



## INTERNAL CLAMPING SLEEVES WITH DOUBLE TAPER

### Use:

for internal clamping

### Advantages:

- double clamping effect
- return effect
- clamps slightly tapered bores

### Running concentricity (truth):

0,01

### Hardness:

The internal clamping sleeves are made from special spring steel. They are hardened – depending on the design – to approx. HRC 48 up to HRC 56.

### Taper of sleeve mandrel:

The taper of the sleeve mandrel should be 15' (one-sided) flatter than the taper angles given in the tables. This frees the clamping sleeves on release.

### type DK

art. no.	d	L	K°	expansion	clamping diameter
DK 0 K	12	24	15	0,5	15 to 20 increment of 0,5
DK 0 L	12	32	15	0,5	15 to 20 increment of 0,5
DK 1 K	17	32	15	0,5	20 to 26 increment of 0,5
DK 1 L	17	48	15	0,5	20 to 26 increment of 0,5
DK 2 K	22	40	15	1,0	26 to 34 increment of 1,0
DK 2 L	22	60	15	1,0	26 to 34 increment of 1,0
DK 3 K	30	50	15	1,0	34 to 45 increment of 1,0
DK 3 L	30	75	15	1,0	34 to 45 increment of 1,0
DK 4 K	40	65	15	1,5	45 to 60 increment of 1,0
DK 4 L	40	95	15	1,5	45 to 60 increment of 1,0
DK 5 K	54	90	15	1,5	60 to 80 increment of 1,0
DK 5 L	54	130	15	1,5	60 to 80 increment of 1,0
DK 6 K	72	120	15	2,0	80 to 110 increment of 2,0
DK 6 L	72	170	15	2,0	80 to 110 increment of 2,0
DK 7 K	95	150	15	2,0	110 to 140 increment of 2,0
DK 7 L	95	220	15	2,0	110 to 140 increment of 2,0

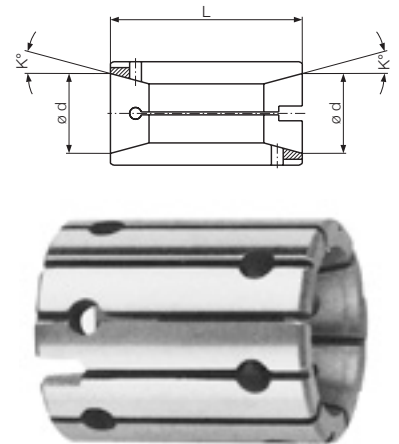

## SLEEVE MANDRELS FOR TYPE S CLAMPING SLEEVES

manually operated or power driven



art. no.	clamping range	A	B	C	D	E	F	S	V	W	X	Y	Z
MFS/KFS 00	20,7	100	75	75	40	54	M10	31,5	21	33	36	47,5	79
MSF/KFS 01	25,7	100	75	75	40	54	M10	36	21	33	36	47,5	83,5
MSF/KFS 02	30,7	100	75	75	46	60	M10	45	21	33	37	48	93
MSF/KFS 03	35,7	100	75	75	46	60	M10	49	21	33	41	51,5	100,5
MSF/KFS 04	40,7	100	75	75	46	60	M10	59	21	33	36,5	46	105
MSF/KFS 05	45,7	130	105	105	70	84	M10	59	21	33	37,5	49,5	108,5
MSF/KFS 06	55,7	130	105	105	70	84	M10	79	21	33	35,5	47	126
KFS 07	65,7	130	105	105	70	84	M10	89	21	33	35,5	47	136
KFS 08	82,7	160	130	130	83	103	M12	99	23	35	35	47	146
KFS 09	101,7	160	130	130	91	160	M12	121	21	21	/	33	154
KFS 10	120,7	160	130	130	87	160	M12	138,9	21	21	/	37	176
KFS 11	140,7	160	130	149	107	160	M12	171	25	25	/	57	228

Spacer adaptor and clamping screw are not included in the delivery and have to be requested separately.

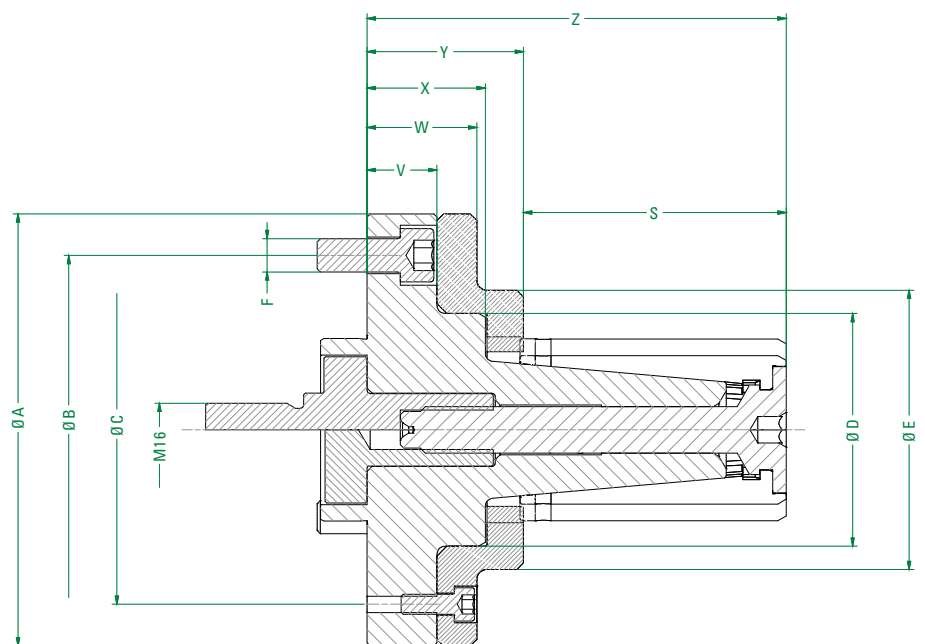

## INTERNAL CLAMPING SLEEVES WITH SINGLE TAPER TYPE S COLLETS

### Use:

- for internal clamping when
  - grinding
  - turning
  - concentricity control
- manually operated
- power driven

### Mounting of sleeve mandrels:

- between turning centres
- at the cylindrical shank
- via Morse taper
- via cylindrical adapting and plan surface

### running concentricity (truth):

0,01

### type S

art. no.	d	L	expansion	clamping diameter
S 00	12,99	35	1	14,7 to 19,7 increment of 0,5
S 01	17,94	40	1	19,7 to 24,7 increment of 0,5
S 02	21,92	46	1	24,7 to 29,7 increment of 0,5
S 03	25,83	50	1	29,7 to 34,7 increment of 0,5
S 04	30,52	60	1	34,7 to 39,7 increment of 0,5
S 05	35,08	60	1	39,7 to 44,7 increment of 0,5
S 06	39,77	80	2	44,7 to 54,7 increment of 1,0
S 07	48,97	90	2	54,7 to 64,7 increment of 1,0
S 08	58,02	100	2	64,7 to 81,7 increment of 1,0
S 09	71,11	122	2	81,7 to 100,7 increment of 1,0
S 10	85,95	140	2	100,7 to 110,7 increment of 1,0
S 10	85,95	140	2	112,7 to 118,7 increment of 2,0
S 11	105,64	180	2	119,7 to 127,7 increment of 1,0
S 11	105,64	180	2	129,7 to 139,7 increment of 2,0

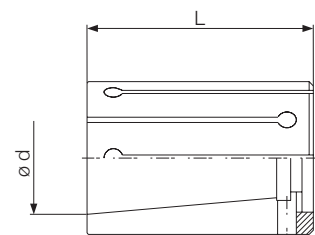

## SLEEVE MANDRELS FOR TYPE E CLAMPING SLEEVES

### manually operated



art. no.	clamping range	E	L	A	B	C	center DIN 332 B	weight daN
MZE 00	8 - 9	40	75	8	4,2	3	1,25	0,2
MZE 01	10 - 11	43	110	10	4,8	3	1,6	0,55
MZE 02	12 - 13	60	125	12	6,0	4	1,6	0,75
MZE 03	14 - 15	70	140	14	7,1	4	2,0	1,25
MZE 04	16 - 18	70	150	16	8,6	4	2,5	1,78
MZE 05	19 - 21	80	170	19	10,5	4	2,5	3,1
MZE 06	22 - 24	80	175	21	12,2	4	2,5	3,4
MZE 07	25 - 34	100	225	25	14,3	4	3,15	6,5
MZE 08	35 - 44	100	225	33	22,5	5	4,0	12,0
MZE 09	45 - 54	125	300	45	30,5	5	4,0	29,3
MZE 10	55 - 65	135	330	53	37,7	5	5,0	46,6
MZE 11	68 - 80	150	350	64	48,0	5	5,0	74,0
MZE 12	80 - 100	150	350	76	59,8	5	6,3	104,0
MZE 13	105 - 135	170	400	99	80,3	5	6,3	198,0
MZE 14	135 - 180	180	420	124	99,7	50	10,0	
MZE 15	185 - 230	200	420	150	124,0	40	10,0	

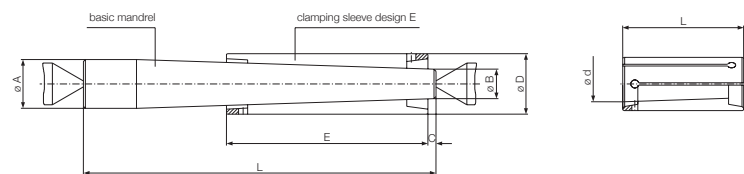

## INTERNAL CLAMPING SLEEVES WITH SINGLE TAPER TYPE E

### Use:

- for internal clamping when
  - grinding
  - turning
  - concentricity control
- manually operated, self-locking

### Mounting of sleeve mandrels:

- between turning centres

### Hardness:

The internal clamping sleeves are made from special spring steel. They are hardened – depending on the design – to approx. HRC 48 up to HRC 56.

### Running concentricity (truth):

0,01

### type E

art. no.	d	L	expansion	clamping diameter
E 00	7,055	40	1,5	8 - 9
E 01	8,6	45	1,5	10 - 11
E 02	10,15	60	2	12 - 13
E 03	12,11	70	2	14 - 15
E 04	13,57	70	2	16 - 17 - 18
E 05	16,09	80	2	19 - 20 - 21
E 06	17,73	80	2	22 - 23 - 24
E 07	21,33	100	3	25 - 26 - 28 - 30 - 32 - 34
E 08	29,55	100	3	35 - 36 - 38 - 40 - 42 - 44
E 09	39,19	125	5	45 - 48 - 50 - 52 - 54
E 10	47,15	135	5	55 - 58 - 60 - 62 - 65
E 11	58,43	150	5	68 - 70 - 72 - 75 - 78 - 80
E 12	70,95	150	5	80 - 85 - 90 - 95 - 100
E 13	91,76	170	5	105 - 110 - 115 - 120 - 125 - 130 - 135
E 14	115,11	180	5	135 - 140 - 145 - 150 - 155 - 160 - 165 - 170 - 175 - 180
E 15	140,1	200	5	185 - 190 - 195 - 200 - 205 - 210 - 215 - 220 - 225 - 230

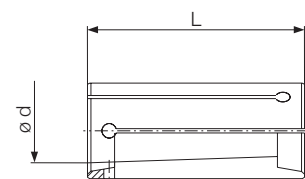

## SLEEVE MANDRELS FOR TYPE B CLAMPING SLEEVES

### power driven

art. no.	clamping range	A	B	G - h6	N	O	C	E	F	H	J	L	M
KFB 00	5,5 - 7,0	45	36	25	5,5	24	14	9,0	30,0	42,5	11,5	51,5	M 8
KFB 01	7,5 - 9,0	50	39	25	6,6	31	14	12,5	33,0	46,0	12,0	58,5	M 8
KFB 02	9,5 - 11,5	56	46	30	6,6	38	15	16,0	39,0	54,0	13,0	70,0	M 10
KFB 03	12,0 - 14,5	60	50	30	6,6	40	15	22,0	43,5	58,5	13,0	78,5	M 10
KFB 04	14,5 - 19,0	72	60	30	6,6	52	15	24,0	50,0	66,0	14,0	90,0	M 10
KFB 05	19,5 - 24,5	76	64	40	6,6	54	18	30,0	51,0	67,0	14,0	97,0	M 12
KFB 06	24,7 - 28,7	82	70	40	6,6	60	18	36,0	55,0	71,0	14,0	107,0	M 12

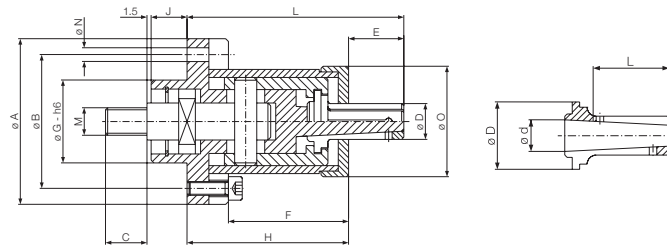

### manually operated

art. no.	clamping range	sleeve mandrel type 241-00 (without nut)					nut type 241-60			stop type 241-70		
		L	A	E	centering B	weight	G	H	M	C	F	M
MZB 00	5,5 - 7,0	71,0	10	12,0	2,0	0,40	19,5	22	14 x 1,5	10,8	8,5	7 x 1,0
MZB 01	7,5 - 9,0	79,5	12	16,0	2,0	0,60	23	26	16 x 1,5	13,8	10,5	9 x 1,0
MZB 02	9,5 - 11,5	89,5	12	20,0	2,0	0,92	28	27	20 x 1,5	16,8	13,2	11 x 1,0
MZB 03	12,0 - 14,5	97,5	14	26,0	2,0	1,92	31	29	24 x 1,5	20,8	16,0	14 x 1,0
MZB 04	14,5 - 19,0	102,5	18	30,0	2,0	3,1	38	30	30 x 1,5	26,8	21,0	18 x 1,5
MZB 05	19,5 - 24,5	113,5	20	36,0	2,0	3,6	47	30	36 x 1,5	31,8	26,0	24 x 1,5
MZB 06	24,7 - 28,7	136,0	25	42,5	2,0	6,7	54	40	42 x 1,5	36,8	31,0	30 x 1,5
MZB07	29,7 - 33,7	144,5	30	46,0	2,5	9,5	57,5	40	45 x 1,5	41,8	36,0	34 x 1,5
MZB 08	34,7 - 38,7	156,0	40	52,5	2,5	15,5	66	40	52 x 1,5	47,8	41,0	36 x 1,5
MZB 09	39,7 - 43,7	166,5	40	58,0	3,15	19,0	74	40	56 x 1,5	52,8	46,0	40 x 1,5
MZB 10	44,7 - 53,7	197,0	45	76,5	3,15	28,0	83	45	65 x 2,0	61,8	55,5	52 x 2,0
MZB 11	54,7 - 63,7	208,5	50	85,0	4,0	40,0	93	48	75 x 2,0	71,8	65,5	62 x 2,0
MZB 12	64,7 - 78,7	221,5	50	96,0	5,0	63,0	108	50	95 x 2,0	90,8	83,0	75 x 2,0

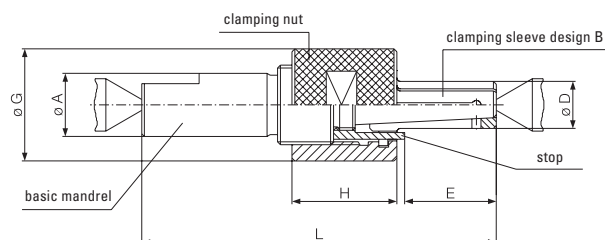

## INTERNAL CLAMPING SLEEVES WITH SINGLE TAPER TYPE B

### Use:

- for internal clamping when
  - grinding
  - turning
  - concentricity control
- manually operated via clamping nut

### Mounting of sleeve mandrels:

- between turning centres
- at the cylindrical shank
- via Morse taper

### running concentricity (truth):

0,01

### type B

art. no.	d	D	L	expansion	bayonet	clamping diameter
B 00	4,64	12,0	13,5	0,5	3 - fold	5,5 to 7,0 increment of 0,5
B 01	6,02	15,5	17,5	0,5	4 - fold	7,5 to 9,0 increment of 0,5
B 02	7,78	18,5	21,5	0,5	4 - fold	9,5 to 11,5 increment of 0,5
B 03	10,56	22,5	27,5	0,5	4 - fold	12,0 to 14,5 increment of 0,5
B 04	12,98	28,5	31,5	0,5	4 - fold	14,5 to 19,0 increment of 0,5
B 05	16,97	33,5	37,5	0,5	4 - fold	19,5 to 24,5 increment of 0,5
B 06	22,42	39,0	44,0	1,0	6 - fold	24,7 to 28,7 increment of 1,0
B 07	26,33	44,0	47,5	1,0	6 - fold	29,7 to 33,7 increment of 1,0
B 08	31,02	50,0	54,0	1,0	6 - fold	34,7 to 38,7 increment of 1,0
B 09	35,6	55,0	59,5	1,0	6 - fold	39,7 to 43,7 increment of 1,0
B 10	40,29	65,0	78,0	1,0	8 - fold	44,7 to 53,7 increment of 1,0
B 11	49,5	75,0	68,5	1,0	8 - fold	54,7 to 63,7 increment of 1,0
B 12	60,36	94,0	97,5	1,0	10 - fold	64,7 to 87,7 increment of 1,0

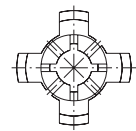
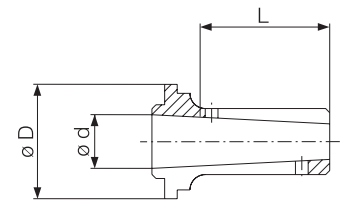

4-fold bayonet

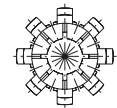

8-fold bayonet

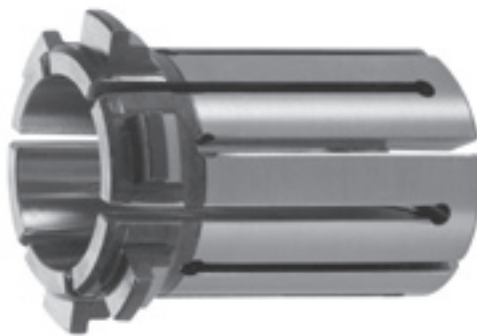

## SEGMENTED CLAMPING MANDRELS

Segmented clamping mandrels with hardened steel segments are especially suited for clamping workpieces having an inner geometry accessible from outside in the form of boreholes or a prismatic take-up. Main applications are turning, grinding, milling, toolcutting, balancing, centering, drilling, etc.

- hardened low-wear steel segments
- ideal workpiece stability thanks to the axis draw effect
- high concentricity and repeat accuracy
- high clamping force and compact design
- prepared for part-in-place check

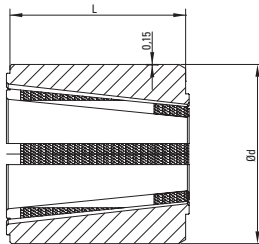
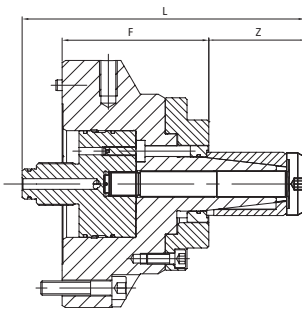

### type KSVZ

art. no.	L	F	Z	max. clamping diameter	max. operating power kN
KSVZ - 00	126	75,0	28,5	29	7
KSVZ - 01	131	75,0	33,5	40	10
KSVZ - 02	159	82,5	54,0	56	20
KSVZ - 03	169	84,5	62,0	83	25
KSVZ - 04	182,5	86,0	74,0	107	30

### segmented clamping sleeves type SVZ

art. no.	L	expansion	clamping diameter
SVZ - 00	23	1,2	19,7 - 27,7 increment of 1,0
SVZ - 01	27	1,2	25,7 - 38,7 increment of 1,0
SVZ - 02	44	1,2	35,7 - 54,7 increment of 1,0
SVZ - 03	50	1,2	50,7 - 81,7 increment of 1,0
SVZ - 04	60	1,2	72,7 - 105,7 increment of 1,0



## SEGMENTED CLAMPING MANDRELS, FIXED SLEEVE

Segmented clamping mandrels with hardened steel segments are especially suited for clamping workpieces having an inner geometry accessible from outside in the form of boreholes or a prismatic take-up. Main applications are turning, grinding, milling, centering, drilling, measuring, etc.

- hardened low-wear steel segments
- high concentricity and repeat accuracy
- high clamping force
- compact design
- no axial movement of clamping sleeve

### type KSVD

art. no.	Y min	Z	max. clamping diameter	max. operating power kN
KSVD - 00	80	96,8	16	7,5
KSVD - 01	80	98,8	25	10
KSVD - 02	103	127,1	35	20
KSVD - 03	103	131,1	46	25
KSVD - 04	108	150,1	66	30
KSVD - 05	105	151,1	86	35
KSVD - 06	109	166,1	106	40
KSVD - 07	109	176,1	131	50

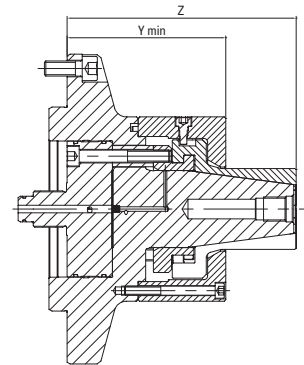

### segmented clamping sleeves type SVD

art. no.	L	expansion	clamping diameter
SVD - 00	38	0,6	9,7 - 15,7 increment of 0,5
SVD - 01	40	0,6	13,7 - 24,7 increment of 0,5
SVD - 02	52,5	0,6	18,7 - 34,7 increment of 0,5
SVD - 03	57	1,2	26,7 - 44,7 increment of 1,0
SVD - 04	76	1,2	36,7 - 64,7 increment of 1,0
SVD - 05	82	1,2	53,7 - 84,7 increment of 1,0
SVD - 06	95	1,2	71,7 - 104,7 increment of 1,0
SVD - 07	105	1,2	94,7 - 129,7 increment of 1,0

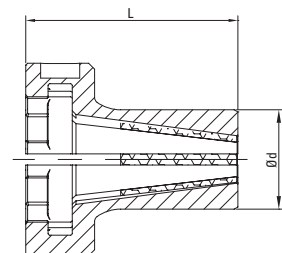

## DIN ISO 10897 COLLETS FOR TOOL CLAMPING

### Double-taper collets according to DIN ISO 10897

- for tools with cylindrical shank
- for tools with thread for draw-in bolt

### Clamping tolerance:

Type A collets:

for tool shanks with tolerance h 10

Type B collets:

Clamping tolerance -0.5 mm

### Hardness:

Type A collets (slotted on one end) have a head hardness of approx. HRc 60 and are partially tempered in the area at the end of the slots. Type B collets, because of the clamping tolerance, are hardened to approx. HRc 46.

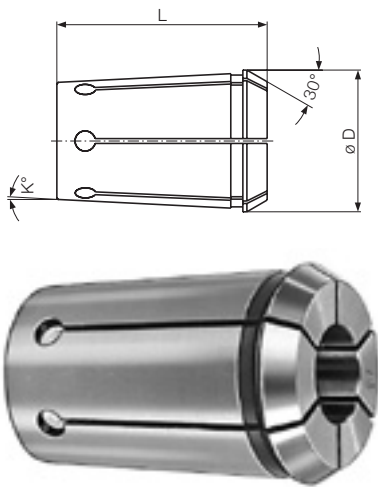

### type A: single-slotted, h 10 clamping tolerance

art. no.	D	L	taper	clamping range
400 E	11,5	21	1 : 10	1 - 6
401 E	14,5	26	1 : 10	1 - 8
404 E	17,2	30	1 : 10	1 - 10
407 E	19,9	34	1 : 10	1 - 12
410 E	25,5	40	1 : 10	2 - 16
444 E	35,05	52	1 : 10	2 - 25
450 E	44,0	60	1 : 10	4 - 32
453 E	52,5	68	1 : 10	6 - 11
486 E	64,2	80	1 : 10	8 - 29

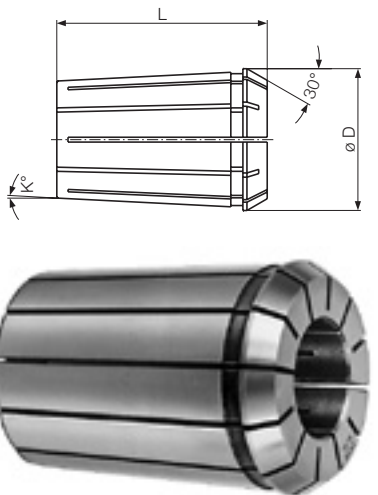

### type B: double-slotted, -0.5 clamping tolerance

art. no.	D	L	taper	clamping range
415 E	25,5	40	1 : 10	2 - 16
4541 E	30,0	45	1 : 10	2 - 20
462 E	35,05	52	1 : 10	2 - 25
467 E	44,0	60	1 : 10	6 - 32
468 E	52,5	68	1 : 10	12 - 40
486 E	64,2	80	1 : 10	30 - 50

### running concentricity - Collets DIN ISO 10897

clamping diameter		testing point L	running concentricity	
d from	d to		standard	high precision
1	1,6	2 - 3	0,015	0,01
1,6	3	10	0,015	0,01
3	6	16	0,015	0,01
6	10	25	0,015	0,01
10	18	40	0,02	0,01
18	24	50	0,02	0,01
24	30	60	0,02	0,01
30	40	60	0,03	0,015

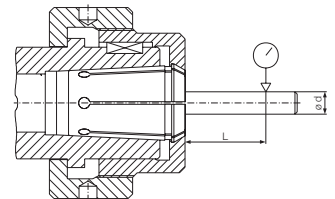

Similar to DIN ISO 10897

## DIN ISO 15488 COLLETS FOR TOOL CLAMPING

### Double-taper collets according to DIN ISO 15488

- for tools with cylindrical shank
- for tools with internal cooling
- for tools with square drive

### Hardness:

Because of the clamping tolerance, collets are hardened to approx. HRc 46.

### Clamping tolerance:

for bores up to 4 mm: -0.5 mm

for bores greater than 4 mm: -1.0 mm

### double-slotted

art. no.	D	L	K°	clamping range
4004 E	8,5	13,5	8	1 - 5
4008 E	11,5	18	8	1 - 7
424 E	12	19,5	8	1 - 7
426 E	17	28	8	1 - 10
428 E	21	32	8	1 - 13
430 E	26	34	8	1 - 16
470 E	33	40	8	2 - 20
472 E	41	46	8	3 - 26
477 E	52	60	8	6 - 34

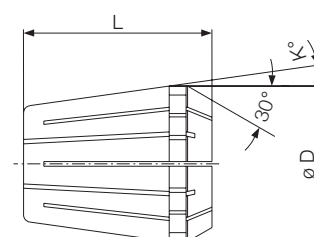

### running concentricity

clamping diameter		testing point L	running concentricity	
d from	d to		standard	high precision
1	1,6	2 - 3	0,015	0,006
1,6	3	10	0,015	0,006
3	6	16	0,015	0,006
6	10	25	0,015	0,006
10	18	40	0,02	0,006
18	24	50	0,02	0,006

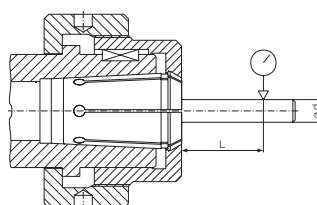

Similar to DIN ISO 15488

Corresponding clamping chucks and clamping nuts on request

## COLLETS FOR TOOL CLAMPING

### System Sandoz-Geniale

#### Collets with single taper and plane surface:

Can be exchanged with DIN ISO 15488

- special nut required
- higher running concentricity

#### Clamping tolerance:

Depending on type and bore: -0.1 to -1.0 mm

#### Hardness:

Because of the clamping tolerance, collets are hardened to approx. HRc 46.

**interchangeable with DIN ISO 15488 collets, new nut required**  
**highest concentricity, perfect balance**

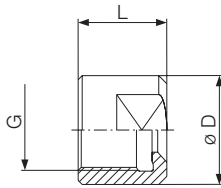
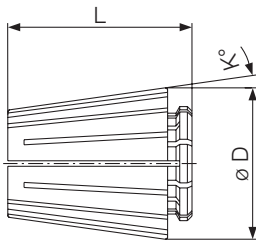

Pic. 1

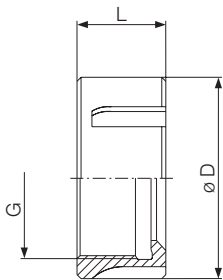

Pic. 2

art. no.	D	L	K°	clamping range
4010 E	12	17	8	0,7 - 7
4018 E	17	24	8	1 - 10
4272 E	21	30,5	8	1 - 13
4280 E	26	34	8	1 - 16
4534 E	33	40	8	2,5 - 20
4768 E	41	46	8	4 - 26

#### nuts for collets system Sandoz-Geniale

art. no.	pic.	collet type	D	L	thread G
TGXE 12	1	4010 E	19	12	M 14 x 0,7
TGXE 16 - 1	1	4018 E	27	15	M 20 x 1
TGXE 16	2	4018 E	32	15	M 22 x 1,5
TGXE 20	2	4272 E	35	16,5	M 25 x 1,5
TGXE 25	2	4280 E	42	18,5	M 32 x 1,5
TGXE 32	2	4534 E	50	22	M 40 x 1,5
TGXE 40	2	4768 E	63	25	M 50 x 1,5

#### system Sandoz-Geniale collets

clamping diameter		testing point L	running concentricity	
d from	d to		standard	high precision
1	1,5	6	0,01	0,005
1,5	3	10	0,015	0,005
3	6	16	0,015	0,005
6	10	25	0,015	0,007
10	18	40	0,02	0,01
18	26	50	0,02	0,012

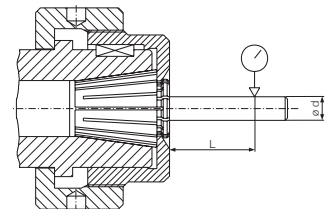

## COLLETS FOR TOOL CLAMPING

### Collets with taper and shank guide

**Clamping tolerance:**

h 10

**Hardness:**

Collets have a head hardness of approx. HRc60 and are partially tempered in the area of the shank guide.

**for tool holders**

art. no.	d	D	L	K°	max. diameter
403 E	12	17	32	10,0	8
413 E	18	27	45	9,25	16
443 E	26	35	50	9,25	20
448 E	32	40,5	53	10,0	26
455 E	42	54	78	10,0	36

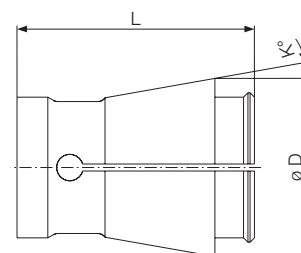

### Collets with single taper and plane surface

**Clamping tolerance:**

h 10

**Hardness:**

Because of the clamping tolerance, collets are hardened to approx. HRc 46.

**for engraving machines**

art. no.	D	L	K°	max. diameter
402 E	15,5	20	10	6
405 E	17,5	24	10	8
408 E	24,0	36	10	12
441 E	34,0	45	10	20
457 E	45,1	66	SK 40	25

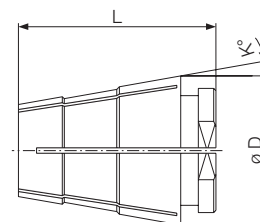

Corresponding clamping chucks and clamping nuts on request



## MORSE- AND ISO-TAPER COLLETS FOR TOOLS WITH CYLINDRICAL SHANK

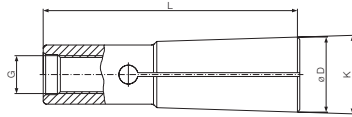

Pic. 1

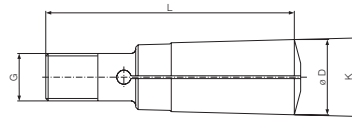

Pic. 2

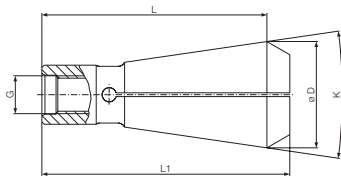

Pic. 3

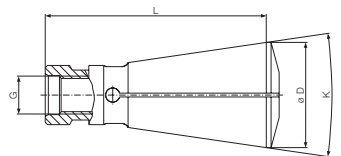

Pic. 4

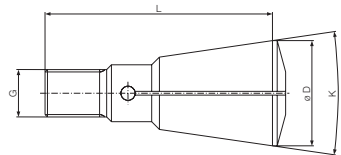

Pic. 5

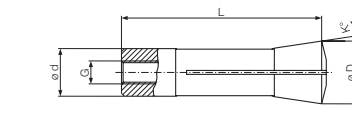

Pic. 6

### Clamping tolerance:

h 10

### Hardness:

Collets have a head hardness of approx. HRc 60 and are partially tempered in the area of the shank guide.

### ISO-taper collets

art. no.	pic.	D	L	L1 max	K°	thread G	max. diameter	remark
541 E	3	32	70,0	78	SK 30	M 12	16	
574 E	5	45	94,0	96	SK 40	S 20 x 2	26	
575 E	4	45	95,3	105	SK 40	M 16	25	channel feeder
575 E - 1	4	45	95,3	99	SK 40	M 16	32	channel feeder and nut
580 E	3	70,7	130,0	140	SK 50	M 24	40	

### Morse taper collets

art. no.	pic.	D	L	L1 max	K°	thread G	max. diameter	remark
503 E	1	18,0	68		MK 2	M 10	14	
536 E	1	24,1	86		MK 3	M 12	18	
539 E	1	31,6	107,5		MK 4	M 16	24	
540 E	2	31,5	105		MK 4	S 20 x 2	25	

### type R8 drawback collets

art. no.	pic.	D	L	L1 max	K°	thread G	max. diameter	remark
369 E	6	24,12	101,5		8,5	7/16" x 1/20"	20	

## COLLETS FOR MULTI-SPINDLE DRILL HEADS AND HAND GRINDERS

### Three Patterns:

- standard pattern
- with internal thread for stop screw
- with square drive for tap drill

### Collets for hand grinders:

These collets can be delivered only with the bore holes indicated. For other diameters an additional charge is required.

### for multi-spindle drill heads

art. no.	pic.	d	D	L	K°	thread G	max. diameter
6023 E	1	5	6,5	20,0	20	M 5 x 0,6	2,9
600 E	1	6	9,0	28,5	10	M 6 x 0,75	4
6043 E	1	6	8,5	25,5	20	M 6 x 0,7	4
601 E	1	8	11,0	33,0	10	M 8 x 0,75	6
603 E	1	8	11,5	30,5	20	M 8 x 0,85	6
6314 E	1	10	14,0	34,0	15	M 10 x 0,75	8
635 E	1	12	18,0	34,0	15	M 12 x 0,75	9

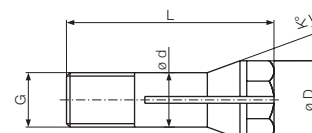

Pic. 1

### for multi-spindle drill heads with driving square for taps

art. no.	pic.	d	D	L	K°	thread G	max. diameter
6023 E - G	2	5	6,5	20,0	20	M 5 x 0,6	2,9
601 E - G	2	8	11,0	33,0	10	M 8 x 0,75	6
603 E - G	2	8	11,5	30,5	20	M 8 x 0,85	6
6314 E - G	2	10	14,0	34,0	15	M 10 x 0,75	8
635 E - G	2	12	18,0	34,0	15	M 12 x 0,75	9

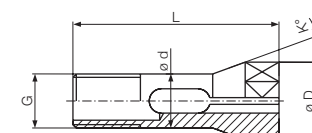

Pic. 2

### for multi-spindle drill heads for stops

art. no.	pic.	d	D	L	K°	thread G	max. diameter
6023 E - A	3	5	6,5	20,0	20	M 5 x 0,6	2,9
601 E - A	3	8	11,0	33,0	10	M 8 x 0,75	6
603 E - A	3	8	11,5	30,5	20	M 8 x 0,85	6
6314 E - A	3	10	14,0	34,0	15	M 10 x 0,75	8
635 E - A	3	12	18,0	34,0	15	M 12 x 0,75	9

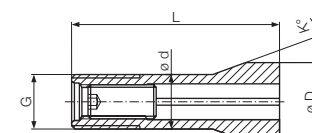

Pic. 3

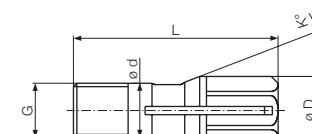

Pic. 4

### for hand grinders

art. no.	pic.	d	D	L	K°	thread G	max. diameter
6071 E	4	8,08	10,0	30,0	21	M 8 x 0,75	6
634 E	5	12	15,0	39,5	10	M 6	6 - 1/4" - 8
6369 E	5	15	18,0	49,0	10	M 8	6 - 8 - 10

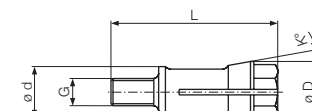

Pic. 5

## SERIES J RUBBER COLLETS

### for DIN 6345 drill holders

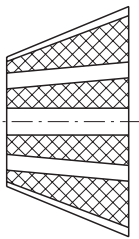

art. no.	type	clamping range
710 E - J 115	41	1,0 - 2,5
710 E - J 116	41	2,5 - 4,5
710 E - J 117	41	4,5 - 6,5
715 E - J 423	42	2,0 - 4,5
715 E - J 420	42	4,5 - 8,0
715 E - J 421	42	3,5 - 6,5
715 E - J 422	42	6,5 - 10,0
750 E - J 444	44	1,8 - 4,5
750 E - J 441	44	4,5 - 10,0
750 E - J 443	44	2,8 - 7,0
750 E - J 440	44	7,0 - 13,0
750 E - J 445	44	9,0 - 15,0
766 E - J 460	46	6,0 - 10,0
766 E - J 461	46	10,0 - 16,0
766 E - J 462	46	16,0 - 23,0

### clamping nuts for DIN 6345 drill holders

art. no.	type	collet type	art. no. of key
J 3157	41	710 E	J 41
J 3158	42	715 E	J 42
J 3159	44	750 E	J 44
J 3159 / S 1	44	750 E - J 445	J 44
J N 460	46	766 E	J 46

Drill holders for rubber collets series J on request

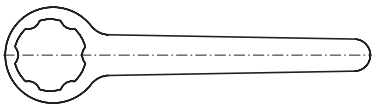



## TYPE FER MILLING CHUCKS FOR DIN ISO 15488 COLLETS

### with DIN 2080 ISO-taper shank

art. no.	collet type	L	L1	D	taper	clamping range
FER 25/SK 30	430 E	43	68	42	SK 30	2 - 16
FER 32/SK 30	470 E	50	68	50	SK 30	4 - 20
FER 32/SK40	470 E	50	93	50	SK 40	4 - 20
FER 40/SK 40	472 E	55	93	63	SK 40	4 - 26
FER 40/SK 50	472 E	58	127	63	SK 50	4 - 26
FER 50/SK 40	477 E	78	93	78	SK 40	12 - 34
FER 50/SK 50	477 E	64	127	78	SK 40	12 - 34

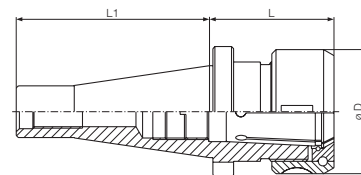

### with DIN 69871 Form A ISO-taper shank

art. no.	collet type	L	L1	D	taper	clamping range
FER 16/SK 30 - 100	426 E	100	48	32	SK 30	1 - 10
FER 16/SK 30 - 70	426 E	70	48	32	SK 30	1 - 10
FER 16/SK 40 - 100	426 E	100	68	32	SK 40	1 - 10
FER 16/SK 40 - 160	426 E	150	68	32	SK 40	1 - 10
FER 16/SK 40 - 70	426 E	70	68	32	SK 40	1 - 10
FER 16/SK 50 - 100	426 E	100	102	32	SK 50	1 - 10
FER 16/SK 50 - 160	426 E	150	102	32	SK 50	1 - 10
FER 25/SK 30 - 60	430 E	60	48	42	SK 30	2 - 16
FER 25/SK 40 - 100	430 E	100	68	42	SK 40	2 - 16
FER 32/SK 30 - 65	470 E	65	48	50	SK 30	4 - 20
FER 32/SK 40 - 160	470 E	150	68	50	SK 40	4 - 20
FER 32/SK 40 - 70	470 E	70	68	50	SK 40	4 - 20
FER 32/SK 50 - 100	470 E	100	102	50	SK 50	4 - 20
FER 32/SK 50 - 160	470 E	160	102	50	SK 50	4 - 20
FER 40/SK 40 - 160	472 E	150	68	63	SK 40	4 - 26
FER 40/SK 40 - 80	472 E	80	68	63	SK 40	4 - 26
FER 40/SK 50 - 100	472 E	100	102	63	SK 50	4 - 26
FER 40/SK 50 - 160	472 E	160	102	78	SK 50	4 - 26
FER 50/SK 50 - 100	477 E	100	102	78	SK 50	12 - 32

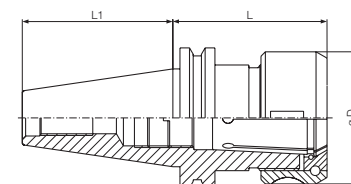

### with morse-taper

art. no.	collet type	L	L1	D	taper	clamping range
FER 16/MK 1	426 E	41,0	52	32	MK 1	1 - 10
FER 20/MK 2	428 E	48,5	63	35	MK 2	2 - 13
FER 25/MK 2	430 E	52,0	63	42	MK 2	2 - 16
FER 32/MK 3	470 E	70,0	80	50	MK 3	4 - 20
FER 32/MK 4	470 E	61,5	101	50	MK 4	4 - 20
FER 40/MK 4	472 E	81,5	101	63	MK 4	4 - 26

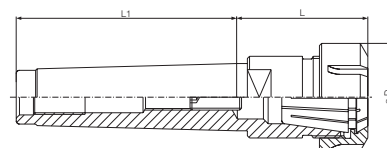

## TYPE FER MILLING CHUCKS FOR DIN ISO 15488 COLLETS

### tool holder type HSK DIN 69893 with nut

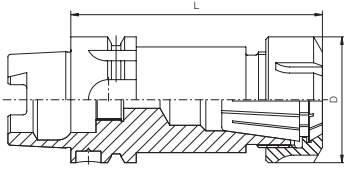

art. no.	collet type	L	D	clamping range
HSK - A 32 / ER 16 x 60	426 E	60	28	1 - 10
HSK - A 32 / ER 20 x 60	428 E	60	34	2 - 13
HSK - A 40 / ER 16 x 80	426 E	80	28	1 - 10
HSK - A 40 / ER 25 x 80	430 E	80	42	2 - 16
HSK - A 50 / ER 25 x 80	430 E	80	42	2 - 16
HSK - A 63 / ER 16 x 100	426 E	100	28	1 - 10
HSK - A 63 / ER 25 x 80	430 E	80	42	2 - 16
HSK - A 63 / ER 32 x 100	470 E	100	50	4 - 20
HSK - A 100 / ER 40 x 120	472 E	120	63	4 - 26

### with cylindrical shank and mini-nut

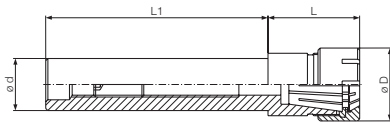

art. no.	collet type	L	L1	D	d	clamping range
FER 8M / 8 x 80	4004 E	26	80	12	8	1 - 5
FER 8M / 12 x 80	4004 E	16	80	12	12	1 - 5
FER 11M / 16 x 150	4008 E	33	150	16	16	1 - 7
FER 11M / 5/8" x 150	4008 E	33	150	16	5/8"	1 - 7
FER 16M / 12 x 80	426 E	38	80	22	12	1 - 10
FER 16M / 20 x 155	426 E	42	155	22	20	1 - 10
FER 16M / 3/4" x 155	426 E	42	155	22	3/4"	1 - 10
FER 20M / 16 x 100	428 E	42	100	28	16	2 - 13
FER 20M / 25 x 155	428 E	42	155	28	25	2 - 13
FER 20M / 1" x 155	428 E	42	155	28	1"	2 - 13

### double tool holder with plane surface for radial fixing and mini-nut

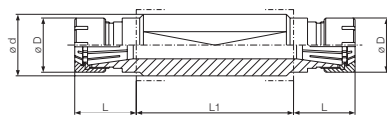

art. no.	collet type	L	L1	D	d	clamping range
FER-D 11M / 16 x 50	4008 E	20	50	16	16	1 - 7
FER-D 11M / 20 x 50	4008 E	20	50	16	20	1 - 7
FER-D 11M / 3/4" x 70	4008 E	20	70	16	3/4"	1 - 7
FER-D 16M / 20 x 55	426 E	26	55	22	20	1 - 10
FER-D 16M / 22 x 55	426 E	26	55	22	22	1 - 10
FER-D 16M / 25 x 62	426 E	26	62	22	25	1 - 10
FER-D 16M / 3/4" x 55	426 E	28	55	22	3/4"	1 - 10
FER-D 16M / 1" x 62	426 E	28	62	22	1"	1 - 10

with cylindrical shank and standard nut

art. no.	collet type	L	L1	D	d	clamping range
FER 16 / 14 x 60	426 E	36	60	28	14	1 - 10
FER 16 / 16 x 60	426 E	36	60	28	16	1 - 10
FER 16 / 20 x 50	426 E	30	50	28	20	1 - 10
FER 16 / 20 x 100	426 E	30	100	28	20	1 - 10
FER 16 / 5/8" x 60	426 E	36	60	28	5/8"	1 - 10
FER 16 / 3/4" x 50	426 E	36	50	28	3/4"	1 - 10
FER 16 / 3/4" x 100	426 E	36	100	28	3/4"	1 - 10
FER 20 / 20 x 30	428 E	36	30	34	20	2 - 13
FER 20 / 20 x 60	428 E	36	60	34	20	2 - 13
FER 25 / 20 x 50	430 E	47	50	42	20	2 - 16
FER 25 / 20 x 100	430 E	47	100	42	20	2 - 16
FER 25 / 25 x 50	430 E	47	50	42	25	2 - 16
FER 25 / 25 x 100	430 E	47	100	42	25	2 - 16
FER 25 / 1" x 50	430 E	47	50	42	1"	2 - 16
FER 32 / 20 x 50	470 E	54	50	50	20	4 - 20
FER 32 / 20 x 100	470 E	54	100	50	20	4 - 20
FER 32 / 25 x 50	470 E	53	50	50	25	4 - 20
FER 32 / 1" x 50	470 E	53	50	50	1"	4 - 20
FER 32 / 1 1/4" x 60	470 E	53	60	50	1 1/4"	4 - 20
FER 40 / 25 x 50	472 E	60	50	63	25	4 - 26
FER 40 / 1" x 50	472 E	60	50	63	1"	4 - 26

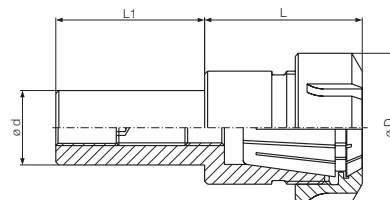

with cylindrical shank and plane surface for radial fixing

art. no.	collet type	L	L1	D	d	clamping range
FER 25/32 F	430 E	32	60	42	32	2 - 16
FER 32/32 F	470 E	38	60	50	32	4 - 20
FER 32/40 F	470 E	33	80	50	40	4 - 20
FER 40/40 F	472 E	55	75	63	40	4 - 26

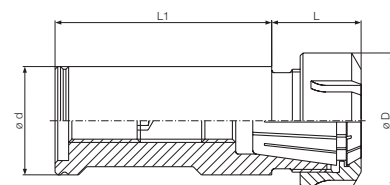

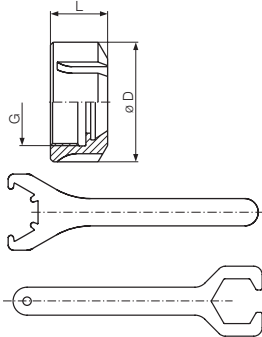

**standard nuts**

art. no.	collet type	D	L	thread G	art. no. of key
Hi - Q / ER 11	4008 E	19	11,3	M 14 x 0,75	E 11 P
Hi - Q / ER 16	426 E	28	17,5	M 22 x 1,5	E 16 P
Hi - Q / ER 20	428 E	34	19,0	M 25 x 1,5	E 20 P
Hi - Q / ER 25	430 E	42	20,0	M 32 x 1,5	E 25
Hi - Q / ER 32	470 E	50	22,5	M 40 x 1,5	E 32
Hi - Q / ER 40	472 E	63	25,5	M 50 x 1,5	E 40
Hi - Q / ER 50	477 E	78	36,3	M 64 x 2,0	E 50
UX / ER 16	426 E	32	17,5	M 22 x 1,5	E 16
UX / ER 20	428 E	35	19,0	M 25 x 1,5	E 20

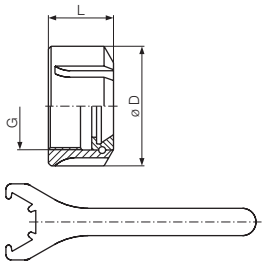

**nuts with bearing**

art. no.	collet type	D	L	thread G	art. no. of key
Hi - Q / ERB 16	426 E	28	20,2	M 22 x 1,5	E 16 P
Hi - Q / ERB 20	428 E	34	21,7	M 25 x 1,5	E 20 P
Hi - Q / ERB 25	430 E	42	22,6	M 32 x 1,5	E 25
Hi - Q / ERB 32	470 E	50	25,0	M 40 x 1,5	E 32
Hi - Q / ERB 40	472 E	63	28,2	M 50 x 1,5	E 40
Hi - Q / ERB 50	477 E	78	38,1	M 64 x 2,0	E 50

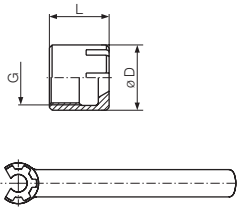

**mini-nuts**

art. no.	collet type	D	L	thread G	art. no. of key
Hi - Q / ERM 8	4004 E	12	10,8	M 10 x 0,75	E 8 M
Hi - Q / ERM 11	4008 E	16	12	M 13 x 0,75	E 11 M
Hi - Q / ERM 16	426 E	22	18	M 19 x 1,0	E 16 M
Hi - Q / ERM 20	428 E	28	19	M 24 x 1,0	E 20 M
Hi - Q / ERM 25	430 E	35	20	M 30 x 1,0	E 25 M

## TYPE NPZT PNEUMATIC CLAMPING UNITS WITH MECHANICAL INDEXING

- drawback collets are especially suited for applications using short workpieces
- allows close length tolerances to be reached regardless of variations in the diameter of the workpieces being used
- integrated 3/2-path valve
- lever-operated indexing
- indexing plate can easily be changed
- regular or irregular indexing

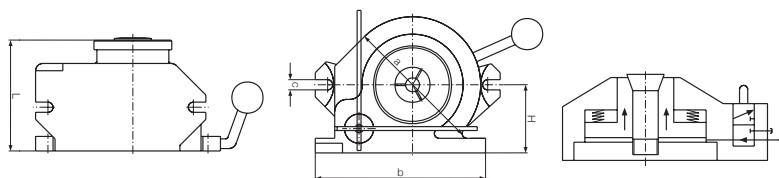

### type NPZT

art. no.	a	b	c	center height H	axial height	through bore	max. clamping- $\phi$	collet type	indexing angle		piston surface cm <sup>2</sup>	weight kg
									max.	min.		
NPZT 8	110	135	8,5	55	90	8 $\phi$	10 $\phi$ x 30	319 E	120°	30°	44	4
NPZT 9	110	135	8,5	55	90	11 $\phi$	14 $\phi$ x 35	330 E	120°	30°	44	4
NPZT 10	140	175	10,5	70	115	18 $\phi$	20 $\phi$ x 45	359 E	120°	26°	65	10
NPZT 11	140	175	10,5	70	120	22 $\phi$	25 $\phi$	367 E	120°	26°	65	10
NPZT 15	190	225	10,5	96	120	22 $\phi$	25 $\phi$	367 E	120°	20°	164	19
NPZT 17	190	225	10,5	96	130	38 $\phi$	42 $\phi$	390 E	120°	20°	148	20

## TYPE VLK-8 MECHANICAL CLAMPING AND INDEXING UNITS

- 2 – 3 – 4 – 6 – 8 – 12 – 24 indexing possible
- hardened and ground positioning cylinder
- workpiece mount for standard draw-back collets
- indexing adjustment via slide plate and two clamping plates
- 30 seconds set-up from one indexing to the next
- precise concentricity 1/100 mm
- positioning cylinder can be clamped
- more production thanks to fast positioning
- no indexing mistakes
- surface coated housing
- holding fixture in vice or on magnet plate
- special holding fixture with additional basic plate or slope with 2 x 90 ° sinus indexing
- the indexing unit is suitable for light milling, drilling, surface grinding, eroding or engraving or mounting operations

### type VLK8 mechanical indexing units



art. no.	A	B	C	D	E	F	H	L	clamping range	collet type
VLK8 - 349 E	60	60	30	50	8	110	90	146	1,5 - 20	349 E / W 20
VLK8 - 355 E	60	60	30	50	8	110	90	146	1,5 - 18	355 E
VLK8 - 359 E	60	60	30	50	8	110	90	146	1,5 - 20	359 E
VLK8 - 364 E	70	70	35	60	16	110	100	154	1,5 - 22	364 E / W 25
VLK8 - 367 E	70	70	35	60	16	110	100	154	1,5 - 24	367 E
VLK8 - 3713 E	70	70	35	60	16	110	100	154	1,5 - 30	3713 E / B 32
VLK8 - 386 E	90	90	45	80	20	110	120	160	1,5 - 29	386 E
VLK8 - 390 E	90	90	45	80	20	110	120	160	5,0 - 42	390 E

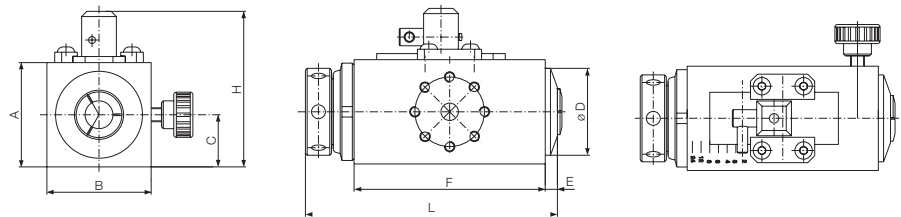

## TYPE PT PNEUMATIC CLAMPING AND INDEXING UNITS

- extremely short indexing time
- drawback collets are especially suited for applications using short workpieces
- indexing plate can easily be changed
- allows close length tolerances to be reached regardless of variations in the diameter of the workpieces being used
- regular or irregular indexing

### type PT

- integrated valves
- integrated micro-switches
- valve box available, mounted either on right or left side
- suitable for SPC control systems

art. no.	dimensions		surface area		center height H	max. through bore	max. clamp.- $\varnothing$	collet type	indexing angle		piston surface cm <sup>2</sup>	weight kg
	e x d	height F	a x b	a x c					max.	min.		
PT 11	227 x 245	150	160 x 175	160 x 100	80	22 $\varnothing$	25 $\varnothing$	367 E	120°	26°	65	26
PT 17	277 x 310	165	210 x 225	210 x 105	105	38 $\varnothing$	42 $\varnothing$	390 E	120°	18°	148	44
PT 22	297 x 335	190	230 x 245	230 x 128	116	62 $\varnothing$	62 $\varnothing$	3955 E	120°	18°	170	60

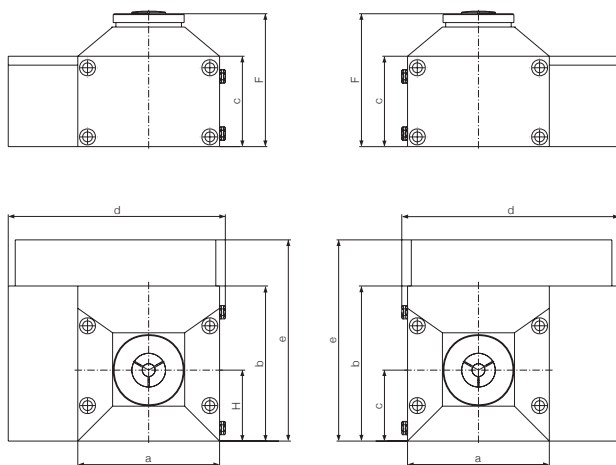

### type PT/W

- without solenoid valves
- without micro-switches

art. no.	dimensions	surface area		center height H	max. through bore	max. clamp.- $\varnothing$	collet type	indexing angle		piston surface cm <sup>2</sup>	weight kg
	height F	a x b	a x c					max.	min.		
PT 11/W	150	160 x 175	160 x 100	80	22 $\varnothing$	25 $\varnothing$	367 E	120°	26°	65	26
PT 17/W	165	210 x 225	210 x 105	105	38 $\varnothing$	42 $\varnothing$	390 E	120°	18°	148	44
PT 22/W	190	230 x 245	230 x 128	116	62 $\varnothing$	62 $\varnothing$	3955 E	120°	18°	170	60

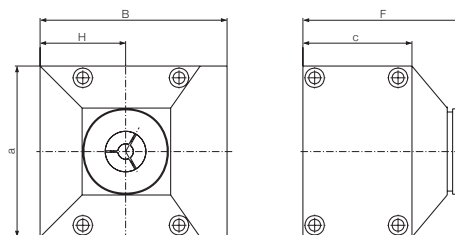
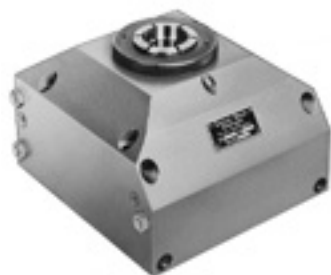

## TYPE NT SINGLE OR MULTI-SPINDLE NUMERIC INDEXING UNITS

- single to four-spindle units
- spindle clamping
- adjustable worm drive
- motors from different manufacturers
- encoders from different suppliers

### type NT



art. no.	spindle nose DIN 55026 Gr.	number of spindles	A	B	H	a	b	c	d	e	f	h	collet type
NT 13.1	3	1	380	346	300		95	190	190	43	11	120	367 E
NT 13.2	3	2	426	346	300	100	95	300	190	43	11	120	367 E
NT 13.3	3	3	526	346	300	100	95	410	190	43	11	120	367 E
NT 13.4	3	4	626	346	300	100	95	510	190	43	11	120	367 E
NT 15.1	5	1	380	358	338		115	320	195	53	13	140	390 E
NT 15.2	5	2	489	358	338	135	115	365	195	53	13	140	390 E
NT 15.3	5	3	624	358	338	135	115	500	195	53	13	140	390 E
NT 15.4	5	4	760	358	338	135	115	635	195	53	13	140	390 E

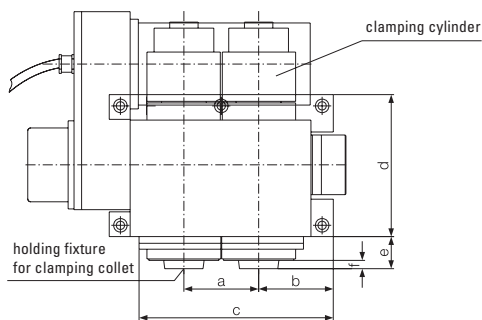

top view

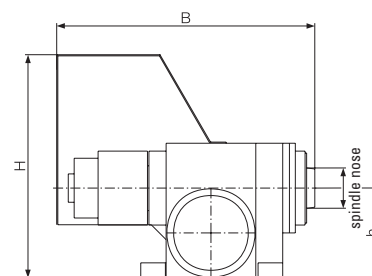
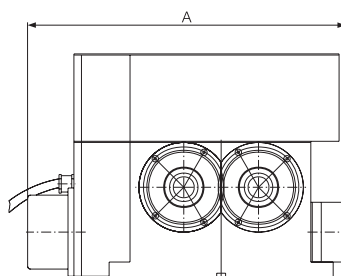



## TYPE NTZ MULTI-SPINDLE INDEXING UNITS

- single to four-spindle units
- indexing via gears
- small dimensions
- integrated, spring-operated collet clamping

### type NTZ

art. no.	number of spindles	A	B	distance between spindles	collet type
NTZ 31.2	2	291	237	75	359 E
NTZ 31.3	3	366	237	75	359 E
NTZ 31.4	4	441	237	75	359 E

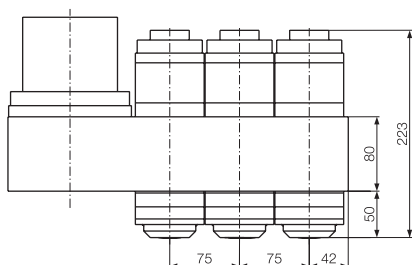

top view

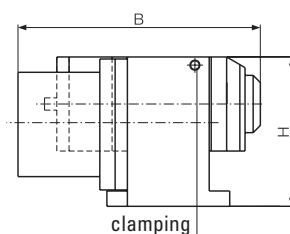
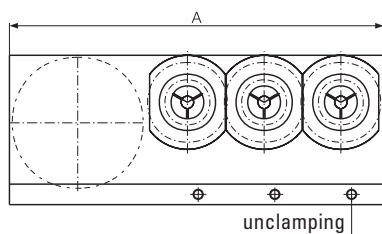

## PNEUMATIC/HYDRAULIC TAILSTOCKS

- small dimensions
- hardened and ground housing
- large sleeve travel
- pneumatic valve for flange mounting

### type HR



HR 1.70  
HR 2.90

art. no.	H	holding fixture	stroke	A	B	L1	L2	D ø	L3	E	F
HR 1.70	70	MK 1	50	82	70	220	226	25	125	31	66
HR 2.90	90	MK 2	70	108	95	265	270	32	145	40	87

art. no.	holding fixture	taper	tip height H	stroke	sleeve pressure at 20 bar
HR 1.70	light	MK 1	70	50	100 kg
HR 2.90	light	MK 2	90	70	260 kg
HR 3.70	heavy	MK 3	70	100	520 kg
HR 3.90	heavy	MK 3	90	100	520 kg

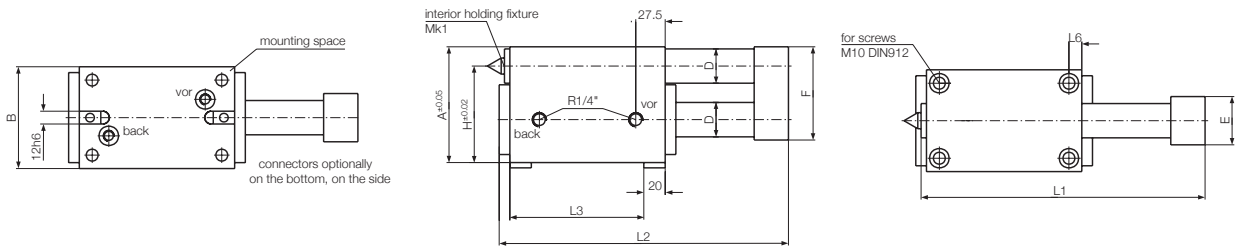

HR 3.70  
HR 3.90

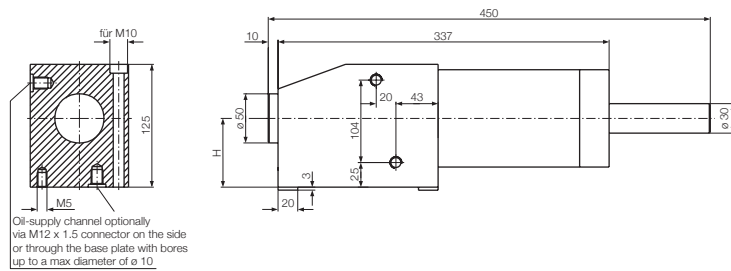
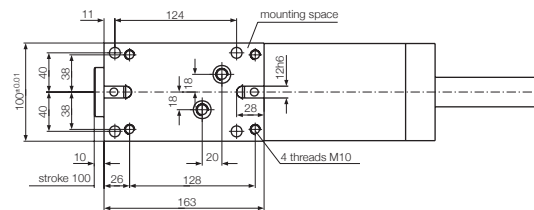





Simon Nann GmbH & Co. KG

Lindenstraße 8

78583 Böttingen

Germany

Phone: +49(0)7429 392-0

Fax: +49(0)7429 392-11

info@nann.de

www.nann.de



tailormade clamping technology